

Errata

Title & Document Type: E2501A 8791 Model 100 Precision Signal Generator
Local Operation Reference

Manual Part Number: E2502-90007

Revision Date: April 1992

HP References in this Manual

This manual may contain references to HP or Hewlett-Packard. Please note that Hewlett-Packard's former test and measurement, semiconductor products and chemical analysis businesses are now part of Agilent Technologies. We have made no changes to this manual copy. The HP XXXX referred to in this document is now the Agilent XXXX. For example, model number HP8648A is now model number Agilent 8648A.

About this Manual

We've added this manual to the Agilent website in an effort to help you support your product. This manual provides the best information we could find. It may be incomplete or contain dated information, and the scan quality may not be ideal. If we find a better copy in the future, we will add it to the Agilent website.

Support for Your Product

Agilent no longer sells or supports this product. You will find any other available product information on the Agilent Test & Measurement website:

www.tm.agilent.com

Search for the model number of this product, and the resulting product page will guide you to any available information. Our service centers may be able to perform calibration if no repair parts are needed, but no other support from Agilent is available.

HP 8791 Model 100

**Precision Signal
Generator ID 2.0
Local Operation Reference**



**HEWLETT
PACKARD**

HP Part No. E2502-90007
Printed in U.S.A.

Contents

1. Introduction	
Purpose of This Manual	1-1
PSID Specifications	1-2
Manual Contents	1-5
How to Use This Manual	1-5
Assumptions	1-6
2. PSID Local Operation	
Introduction	2-1
Chapter Contents	2-2
PSID Front Panel Overview	2-2
PSID Commands	2-3
PSID Default Conditions	2-4
Creating Signals	2-6
AM Example	2-7
FM Example	2-9
PM Example	2-12
FREQ HOP Example	2-14
User Patterns	2-16
User Pattern Characteristics	2-16
PSID Data Scaling	2-17
AM	2-17
FM and PM	2-17
Freq Hop	2-18
PSID Data Compression and Expansion	2-18
Compression	2-19
Expansion	2-19
Clock Rate Dividers	2-19
User Patterns Shipped with PSID	2-20
How to Edit an Existing User Pattern	2-20

How to Use WGL to Create a User	
Pattern	2-21
Carrier Parameters	2-25
Frequency	2-25
Frequency Offset	2-25
Amplitude	2-26
Phase Offset	2-26
Modulation Parameters	2-27
AM	2-28
Mod Rate	2-28
Mod Level	2-28
Mod Waveform	2-29
Rectangular	2-29
User Pattern	2-30
Delay	2-32
FM	2-33
Mod Rate	2-33
Mod Level	2-33
Mod Waveform	2-34
User Pattern	2-34
Delay	2-36
PM	2-37
Mod Rate	2-37
Mod Level	2-37
Mod Waveform	2-37
User Pattern	2-38
Delay	2-39
FREQ HOP	2-41
Mod Rate	2-41
Mod Waveform	2-42
Run	2-44

3. SID Local Operation	
Introduction	3-1
Chapter Contents	3-2
SID Front Panel Overview	3-3
Command Types	3-5
Pull-Down Menus	3-6
Dialog Boxes	3-6
Toggle Ribbon	3-7
Abort!	3-7
Reset	3-7
Shutdown	3-7
WrkStn	3-8
SID	3-8
PSID	3-8
System Busy Indicators	3-9
The SID Environment (Windows)	3-9
Windows Tutorial	3-9
Program Manager	3-10
Screen Saver	3-11
Formatting a Floppy Disk	3-11
Installing a Printer	3-13
SID Control Panel	3-17
Attenuator	3-19
Coherence	3-19
Event Markers	3-20
Group Packet Adv.	3-20
More	3-21
RF Output	3-21
Seq. Jump Source	3-21
System Clock	3-22
Sequencer Model	3-23
Trigger Setting	3-23
SID Extended Control Panel	3-25
Active Memory	3-28
AM Memory Mode	3-28
Dynamic Data Mode	3-28
Memory Address Out	3-29
PM Data Mode	3-29

Rate Divider	3-30
Sequence Jump Type	3-30
Sequence Mode	3-31
Stretch Factor	3-32
SID Event Markers	3-33
Event Marker 1	3-34
Event Marker 2	3-34
Marker Address	3-35
Marker Delay	3-35
Pull Down Menus	3-37
File Menu	3-38
New	3-40
Open	3-40
Save	3-41
Save as	3-41
Print	3-41
Printer Setup	3-42
Exit	3-43
Edit Menu	3-44
Undo	3-45
Cut	3-45
Copy	3-45
Paste	3-45
Clear	3-45
Select All	3-45
Find	3-45
Find Next	3-46
Find Previous	3-46
Paste to WGL	3-46
Utilities Menu	3-47
Shutdown	3-49
System Reset	3-49
Signal Control..	3-51
Start	3-53
Stop	3-53
Trigger	3-53
Pause	3-53
Continue	3-53

Hardware Images ...	3-54
Recall ...	3-55
Save ...	3-55
Clear ...	3-56
Label ...	3-56
Clear All Images ...	3-56
Copy Image to Image ...	3-56
Auto Start ...	3-56
Copy Image to Floppy ...	3-56
Load Image from Floppy ...	3-57
List Images Floppy ...	3-58
ID Settings ...	3-58
Recall ...	3-59
Save ...	3-59
Clear ...	3-59
Label ...	3-59
Clear All Settings ...	3-60
Copy Settings to Floppy ...	3-60
Load Settings From Floppy ...	3-60
List Settings Floppy ...	3-60
User Patterns ...	3-61
Delete ...	3-62
Edit ...	3-62
Rename Pattern ...	3-62
Delete All Patterns ...	3-62
Copy Pattern to Floppy ...	3-62
Install Pattern from Floppy ...	3-62
List Patterns Floppy ...	3-62
Diagnostics ...	3-63
CW Signal ...	3-64
Level Calibration ...	3-65
Test Signal ...	3-65
Options Menu ...	3-71
HP-IB Address ...	3-72
Special Functions ...	3-72
Choose Colors ...	3-77
Choose Font ...	3-78
Toggle Ribbon ...	3-79

WGL Menu	3-80
WGL Stack	3-81
WGL Status	3-81
Clear Workspace	3-81
Load WGL Program	3-81
Store WGL Program	3-81
Window Menu	3-82
Tile	3-83
Cascade	3-83
Arrange Icons	3-83
Help Menu	3-84
WGL Commands	3-85
Error Messages	3-85
Windows Tutorial	3-85
About the HP8791	3-85

Messages

Glossary

Index

Figures

1-1. PSID Front Panel	1-1
2-1. PSID Front Panel	2-3
2-2. Reset Warning Message	2-7
2-3. AM Warning Message	2-8
2-4. AM Two-Tone Test Signal	2-8
2-5. FM Waveform Dialog Box	2-10
2-6. FM CW Radar	2-11
2-7. PM Waveform Dialog Box	2-13
2-8. PM QPSK Modulated Carrier	2-13
2-9. Frequency Hopping Radar	2-15
2-10. Individual Frequency Hop Radar Pulse	2-15
2-11. User Pattern Created in WGL	2-22
2-12. Load Pattern Dialog Box	2-22
2-13. AM Waveform Dialog Box	2-31
2-14. FM Waveform Dialog Box	2-35
2-15. PM Waveform Dialog Box	2-38
2-16. Frequency Hop Waveform Dialog Box .	2-43
3-1. SID Front Panel	3-4
3-2. WGL Workstation	3-8
3-3. Disk Drive Physical Configuration . . .	3-12
3-4. A Drive Release Button	3-13
3-5. Connecting a Printer to the Smart Interface	3-15
3-6. SID Control Panel	3-18
3-7. SID Extended Control Panel	3-25
3-8. SID Event Markers Screen	3-33
3-9. File Menu	3-38
3-10. File Open Dialog Box	3-40
3-11. File Save Dialog Box	3-41
3-12. Print Dialog Box	3-42

3-13. Print Setup Dialog Box	3-42
3-14. Edit Menu	3-44
3-15. Find Dialog Box	3-45
3-16. Utilities Menu	3-47
3-17. Signal Control Dialog Box	3-52
3-18. Hardware Images Dialog Box	3-54
3-19. Application State Settings Dialog Box	3-58
3-20. User Patterns Dialog Box	3-61
3-21. System Diagnostics Dialog Box	3-63
3-22. Model 7 Overall Test Signal	3-66
3-23. Model 11 Overall Test Signal	3-67
3-24. Model 21 Low Band Overall Test Signal	3-67
3-25. Model 21 High Band Overall Test Signal	3-68
3-26. AM Test Signal (Models 11 and 21)	3-68
3-27. Linear Chirp Test Signal (Models 11 and 21)	3-69
3-28. Pulse Carrier Test Signal (Models 11 and 21)	3-69
3-29. Thirteen Element Barker Code Test Signal (Models 11 and 21)	3-70
3-30. Options Menu	3-71
3-31. Special Functions Dialog Box	3-72
3-32. Graph Color Elements Dialog Box	3-77
3-33. Font Dialog Box	3-78
3-34. WGL Menu	3-80
3-35. Window Menu	3-82
3-36. Help Menu	3-84

Tables

2-1. PSID Default Conditions	2-5
2-2. User Patterns Shipped with PSID . . .	2-20
3-1. Valid Parameters Depending on Sequence Mode	3-27
3-2. SID Default Values	3-50
3-3. Special Functions	3-74

Introduction

Purpose of This Manual

This manual provides complete descriptions and definitions of all of the HP 8791 Model 100 Precision Signal Generator Instrument-on-a-Disk (PSID) capabilities.

The information contained in this manual is intended for the system operator or test engineer who uses PSID for testing complex electronic equipment. Figure 1-1 shows the PSID front panel.

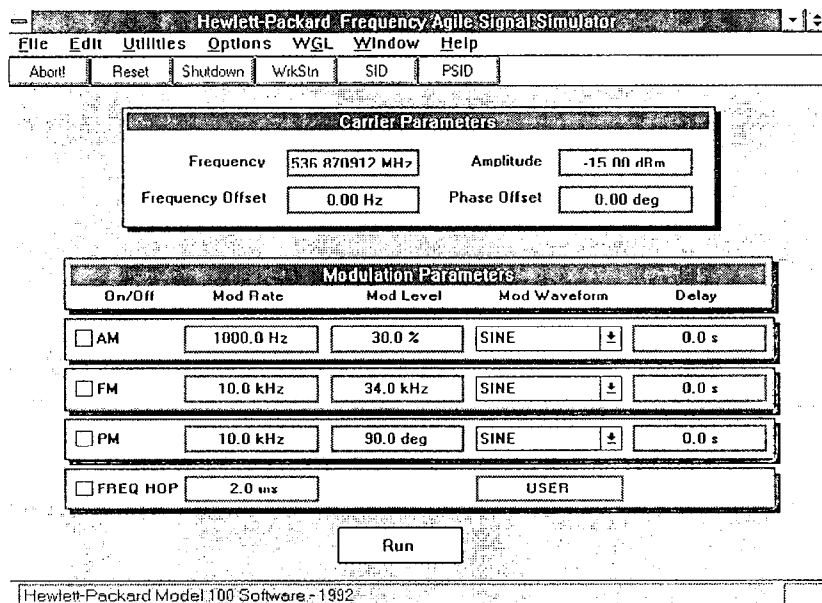

Figure 1-1. PSID Front Panel

PSID Specifications

These specifications describe the warranted performance of the HP 8791 Model 7, 11, and 21 Frequency Agile Signal Simulator when used with the HP 8791 Model 100 Precision Signal Generator Instrument-on-a-Disk software. For additional hardware specifications, see the *HP 8791 System Service Manual*.

FREQUENCY¹

Range: HP FASS Model 7: 0 Hz to 50 MHz, 0.125 Hz resolution
HP FASS Model 11: 0.01 to 3 GHz, 0.125 Hz resolution
HP FASS Model 21: 0.05 to 18 GHz, 0.125 Hz resolution
Accommodates entry to 40 GHz (useful with optional upconverters)

Agile Modes Constant (no hopping)
User-defined

Agile Dwell Time 180 ns to > 1.95 ms
0.1% resolution

Switching Time < 250 ns, 100 ns typical

OUTPUT LEVEL with AM off (<4 dBm with <100% AM)

Range HP FASS Models 7: +10 to -100 dBm
HP FASS Model 11: +10 to -107 dBm
HP FASS Model 21: +10 to -100 dBm

Resolution < 0.1 dB

¹ Specifications determined by internal clock frequency; will vary when using different external clock frequencies.

Modulation	Rate	Modulation Parameters		
		Level	Waveform	Delay
AM	0.0625 Hz-20 MHz ¹ 0.1% resolution	0 to DSB-SC < ±1% resolution for depth < 100%	Sine Rectangle User	0-100% of repetition period ±0.1 resolution (typical)
ΦM	0.625 Hz-20 MHz ¹ 0.1% resolution	0-180° ±0.088° resolution	Sine User	0-100% of repetition period ±0.1% resolution (typical)
FM	0.625 Hz-20 MHz ¹ 0.1% resolution	0.125 Hz-20 MHz ±0.125 Hz resolution	Sine User	0-100% of repetition period ±0.1% resolution (typical)

¹ The lower frequency limit for user-defined waveforms with cubic spline expansion is 0.126 Hz.

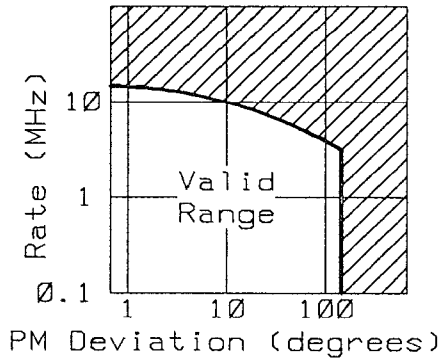

PM RATE AND DEVIATION INCLUDE SIDEBANDS > 50 dBc.

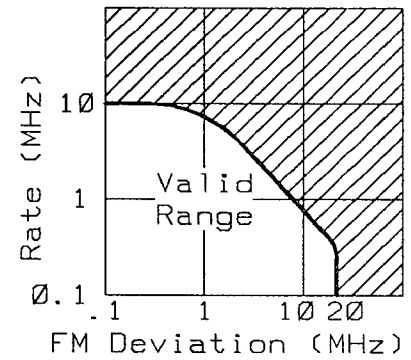

FM RATE AND DEVIATION TO MAINTAIN ≤ 50 dBc SPURS.

DATA STORAGE

Hardware Images (include all hardware data)
5 on Bernoulli™ disk
1 per 3.5 in. floppy disk

Button Settings (include all parameters)
12 on Bernoulli™ disk²
12 per 3.5 in. floppy disk

User-Defined Patterns (up to 8192 points long)
20 on Bernoulli™ disk
20 per 3.5 in. floppy disk

EXTERNAL TRIGGERING See the *HP 8791 Models 10, 11 and 21 Frequency Agile Signal Simulators Technical Data* sheet.
External single not supported.

MARKER OUTPUTS Independent markers are available for each modulation format (AM, Φ M, FM, and Hop). A TTL-level signal is generated at the beginning of each scan of a modulation waveform. For details, see the *HP 8791 Models 10, 11 and 21 Frequency Agile Signal Simulators Technical Data* sheet.

REMOTE OPERATION

HP-IB Capability All parameters can be set over HP-IB. Command set follows the recommended formats of IEEE Std 488.2.

GENERAL See the *HP 8791 Models 10, 11 and 21 Frequency Agile Signal Simulators Technical Data* sheet for HP-IB and environmental specifications.

² If user patterns total more than 8192 points, not all patterns will be saved with button settings.

Manual Contents

The following information is contained in this manual:

- Chapter 1, "Introduction," provides general information and describes how to use the manual.
- Chapter 2, "PSID Local Operation," describes and defines all of the PSID commands that are displayed on the monitor. Using these commands is referred to as front-panel operation.
- Chapter 3, "SID Local Operation," describes and defines all of the System ID menus and commands that are displayed on the monitor.
- Error Messages
- Glossary
- Index

How to Use This Manual

You should read this manual when you need additional information about specific front-panel commands. For HP-IB commands, see the *PSID Remote Operation Reference*. See the *SID Getting Started Guide* to quickly familiarize yourself general system operation.

Information made available after the printing of this manual is stored in a file named `USR\FILES\README.TXT` on the removable cartridge. You can review this file using the ASCII text editor in SID.

Assumptions

This manual assumes the following:

- You have access to an HP FASS system to perform some of the procedures.
- The system is correctly installed and operating (including any required ID software). If this is not true, see the *HP 8791 FASS System Service Manual* for the information required to install or repair the system.

PSID Local Operation

Introduction

Local operation of the Precision Signal Generator Instrument-on-a-Disk (PSID) consists of using the front panel to generate signals.

PSID can be used for general purpose receiver and receiver module testing. It provides a carrier signal, along with the following modulation capabilities:

- Amplitude Modulation
- Frequency Modulation
- Phase Modulation

In addition, the carrier frequency generated by PSID can be hopped, and pulse modulation can be achieved using the AM channel with a rectangular function.

Modulation waveforms for PSID are based on either sine waves, rectangular waveforms (AM only), or user-defined waveforms (also known as user patterns).

Each modulation source is independent in frequency and function. You can select a different modulation waveform for each modulation source.

All of the System ID (SID) and Waveform Generation Language (WGL) capabilities are contained on the PSID removable cartridge and are directly available from the PSID environment. SID local operation is described in chapter 3. WGL is described in a separate manual.

Note

PSID waveform creation is done using WGL. This means that when you leave the WGL environment to use PSID, the contents of the WGL stack and waveform registers may be altered.

Chapter Contents

The following information is contained in this chapter:

- An overview of the PSID front panel.
- A description of how to create a signal with PSID.
- An explanation of user patterns.
- Descriptions of the PSID front panel commands.

PSID Front Panel Overview

The PSID front panel consists of one main screen. See the introduction to chapter 3, “SID Local Operation”, for a description of the different elements on the screen.

Figure 2-1 shows the PSID front panel display.

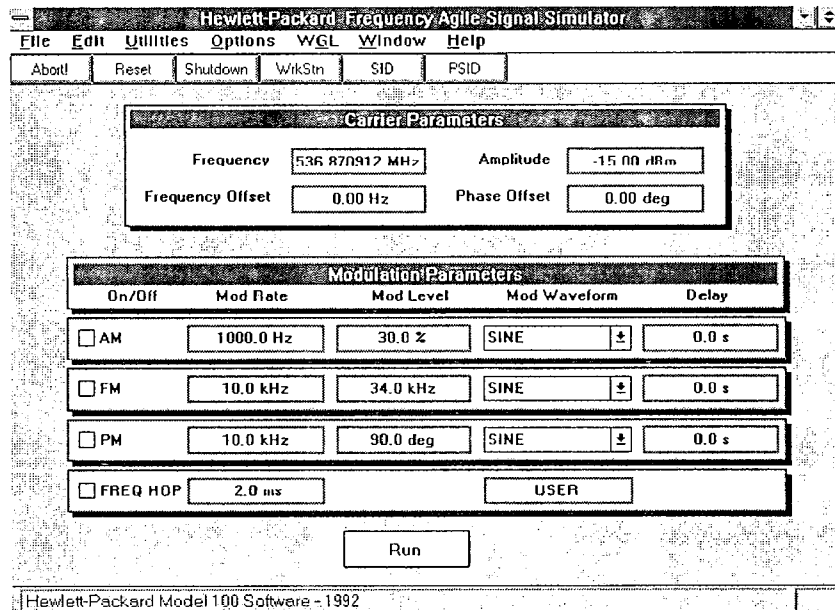

Figure 2-1. PSID Front Panel

PSID Commands

Except for On/Off, front panel commands are selected by clicking on the button face. Most of the commands open dialog boxes. Dialog boxes request additional information in order to implement a command. While a dialog box is open, you cannot access commands on the PSID screen or in the pull-down menus.

In dialog boxes requiring numeric data, termination keys are used to select the required unit of measurement and terminate the entry. The termination key that is outlined in bold or is highlighted can be selected by pressing **Enter** on the keyboard.

The current setting of a command is displayed on its button face.

When a command is active, the button face is highlighted. The color of the highlight can be changed

from the Control Panel in the Windows Program Manager.

**PSID Default
Conditions**

The **Reset** command in the toggle ribbon at the top of the screen resets the system to default conditions. All data that was entered is lost.

Table 2-1 provides a detailed list of the default conditions for the PSID software. See table 3-2 in chapter 3, “SID Local Operation” for a detailed list of SID default conditions.

Table 2-1. PSID Default Conditions

Parameter	Default Value
Carrier	
Amplitude	-15 dBm
Frequency	HP FASS Models 11 and 21: 536.870912 MHz HP FASS Model 7: 33.554432 MHz
Frequency Offset	0 Hz
Phase Offset	0 degrees
AM	
Mod Rate (AM Rate)	1 kHz
Mod Level (AM Depth)	30%
Waveform	Sine
Delay (Phase Delay)	0 seconds
FM	
Mod Rate (FM Rate)	10 kHz
Mod Level (FM Deviation)	34 kHz
Waveform	Sine
Delay (Phase Delay)	0 seconds
PM	
Mod Rate (PM Rate)	10 kHz
Mod Level (PM Deviation)	90°
Waveform	Sine
Delay (Phase Delay)	0 seconds
Frequency Hop	
Mod Rate (Hop Dwell Time)	2 ms
Waveform	CW

Creating Signals

Using PSID to create signals typically involves performing the following steps:

1. Select the carrier mode - either constant or hopped.
 - For a constant carrier, enter the value for Carrier Frequency.
 - For a hopped carrier, turn on **FREQ HOP**, enter the Hop Dwell Time, and select a user-defined waveform.
2. Set the carrier parameters.
 - Enter values for Frequency Offset, Amplitude, and Phase Offset.
3. For each modulation format you want to use (AM, FM, and PM):
 - Turn the modulation on.
 - Set the modulation rate.
 - Set the modulation level (depth for AM; deviation for FM and PM).
 - Choose the desired modulation waveform.
 - Use delay to produce the desired timing between modulations and frequency hopping.
4. Select **(RUN)** to generate the signal

AM Example

This example creates a double-sideband, suppressed carrier, two-tone test signal.

1. Select **Reset**, located near the top of the screen. The warning message shown in Figure 2-2 is displayed.

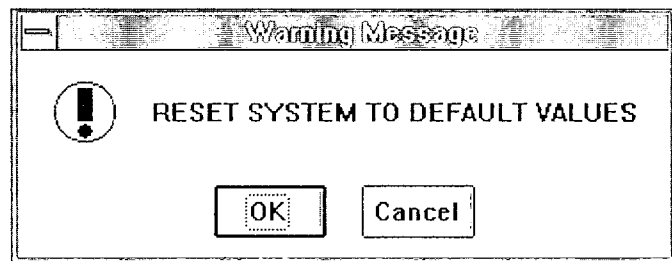

Figure 2-2. Reset Warning Message

2. Select **OK** or press **Enter** on the keyboard.

Note



Anytime one of the command buttons in a dialog box is outlined in bold, you can activate that choice by pressing **Enter** on the keyboard.

3. Set the Carrier Frequency to 40 MHz.

Note



To set a parameter, click on the button face. A dialog box opens, in which you enter the desired setting.

4. Turn on AM by clicking in the AM On/Off box. Verify that an X appears in the box.
5. Set the AM Mod Rate (AM Rate) to 500 kHz.
6. Set the AM Mod Level (AM Depth) to 500001%.

The warning message shown in Figure 2-3 is displayed.

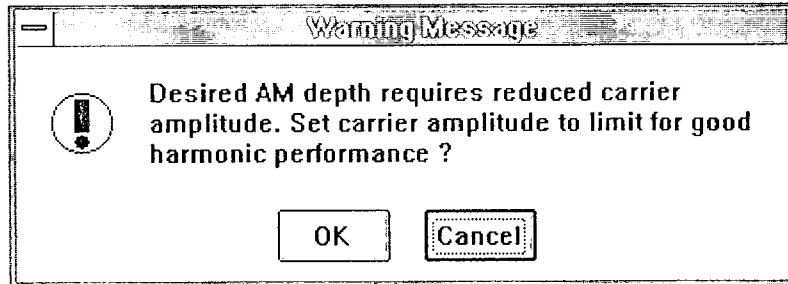

Figure 2-3. AM Warning Message

7. Select **OK**. PSID automatically sets the Carrier Amplitude to -90 dBm.
8. Select **Run** to generate the signal.
9. When the RF output signal is displayed on a spectrum analyzer, it should be as shown in Figure 2-4.

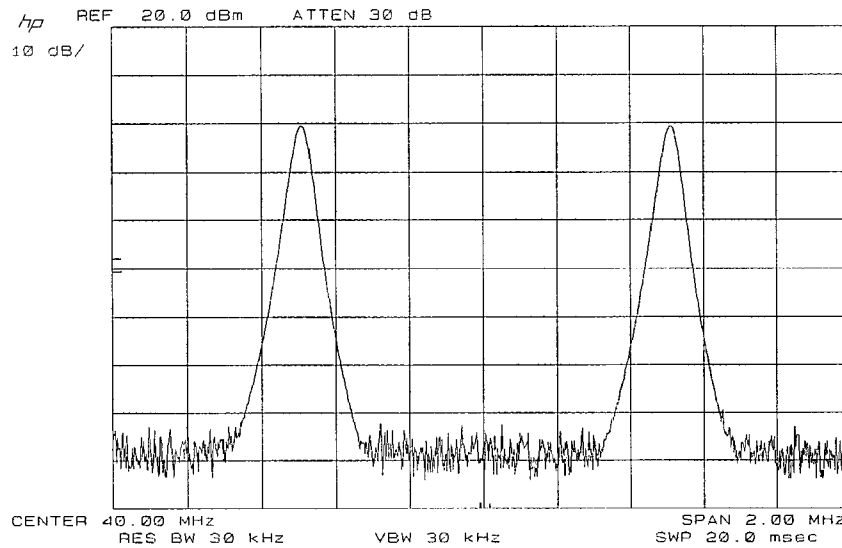

Figure 2-4. AM Two-Tone Test Signal

2-8 PSID Local Operation

FM Example

This example creates an FM CW radar signal.

Note



To do this example, the user pattern named `triangle.usr`, which is shipped with PSID, must be installed on the removable cartridge.

1. Select **Reset**. When the warning message is displayed, select **OK** or press **Enter** on the keyboard.
2. Set the Carrier Frequency to 40 MHz.
3. Turn on FM by clicking in the FM On/Off box. Verify that an X appears in the box.
4. Set the Modulation Parameters for FM as follows:
 - Mod Rate (FM Rate): 10 kHz.
 - Mod Level (FM Deviation): 1 MHz.
 - Mod Waveform: USER
5. When the FM Waveform dialog box (Figure 2-5) is displayed, click on `triangle.usr` to highlight the line. Then select **Select User Pattern**.
6. Set the User Pattern Expansion Mode to **Interpolate**.

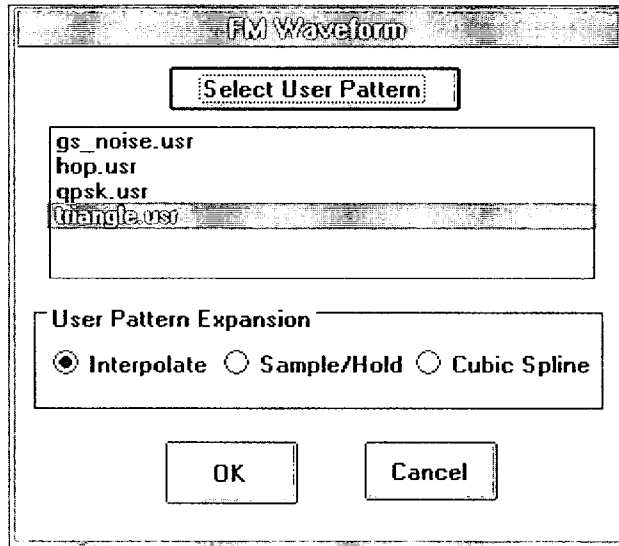

Figure 2-5. FM Waveform Dialog Box

7. Select **OK** to close the dialog box.
8. Select **Run** to generate the signal.
9. When the RF output signal is displayed on a spectrum analyzer, it should be as shown in Figure 2-6.

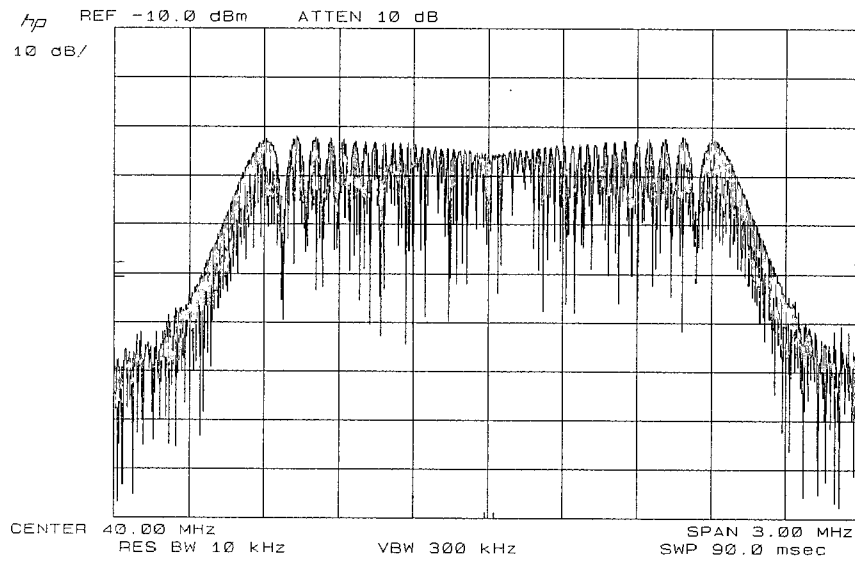

Figure 2-6. FM CW Radar

PM Example

This example creates a QPSK modulated carrier.

Note



To do this example, the user pattern named `qpsk.usr`, which is shipped with PSID, must be installed on the removable cartridge.

1. Select **Reset**. When the warning message is displayed, select **OK** or press **Enter** on the keyboard.
2. Set the Carrier Frequency to 40 MHz.
3. Turn on PM by clicking in the PM On/Off box. Verify that an X appears in the box.
4. Set the Modulation Parameters for PM as follows:
 - Mod Rate (PM Rate): 350 Hz.
 - Mod Level (PM Deviation): 135 deg.
 - Mod Waveform: USER
5. When the PM Waveform dialog box (Figure 2-7) is displayed, click on `qpsk.usr` to highlight the line. Then select **Select User Pattern**.
6. Set the User Pattern Expansion Mode to `Sample/Hold`.
7. Select **OK** to close the dialog box.
8. Select **Run** to generate the signal.
9. When the RF output signal is displayed on a spectrum analyzer, it should be as shown in Figure 2-8.

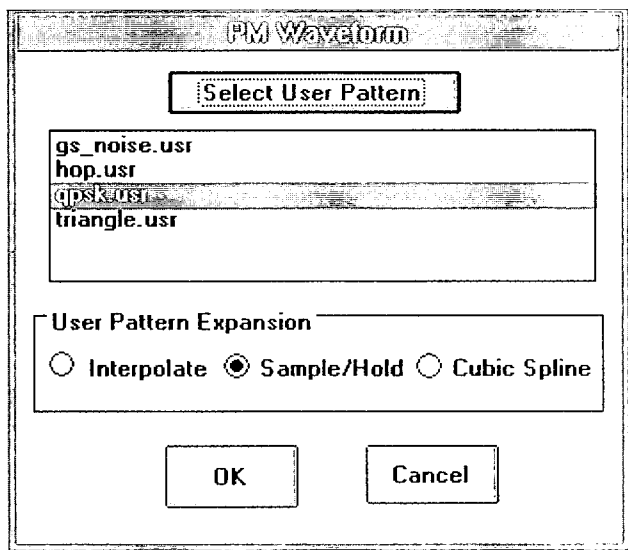

Figure 2-7. PM Waveform Dialog Box

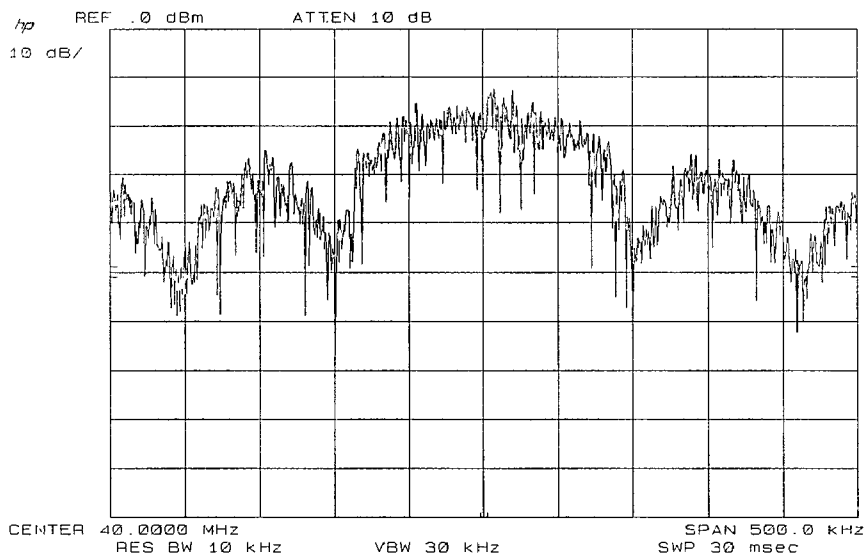

Figure 2-8. PM QPSK Modulated Carrier

FREQ HOP Example

This example creates a frequency hopping radar that uses AM for pulsing.

Note



The frequencies used in this example are beyond the range of HP FASS Model 7 hardware.

1. Select **Reset**. When the warning message is displayed, select **OK** or press **Enter** on the keyboard.
2. Turn on AM by clicking in the AM On/Off box. Verify that an X appears in the box.
3. Set the Modulation Parameters for AM as follows:
 - Mod Rate (AM Rate): 10 kHz.
 - Mod Level (AM Depth): 100%.
 - Mod Waveform: RECTANGULAR; Duty Cycle: 50%.
 - Delay (Phase Delay): 10 μ s.
4. Select frequency hopping by clicking in the FREQ HOP On/Off box. Verify that an X appears in the box.
5. Set the Modulation Parameters for FREQ HOP to the following:
 - Mod Rate (Hop Dwell Time): 100 μ s.
 - Mod Waveform: USER; User Pattern: HOP.USR.
6. Select **Run** to generate the signal.
7. When the RF output signal is displayed on a spectrum analyzer, it should be as shown in Figure 2-9. Figure 2-10 shows an individual pulse.

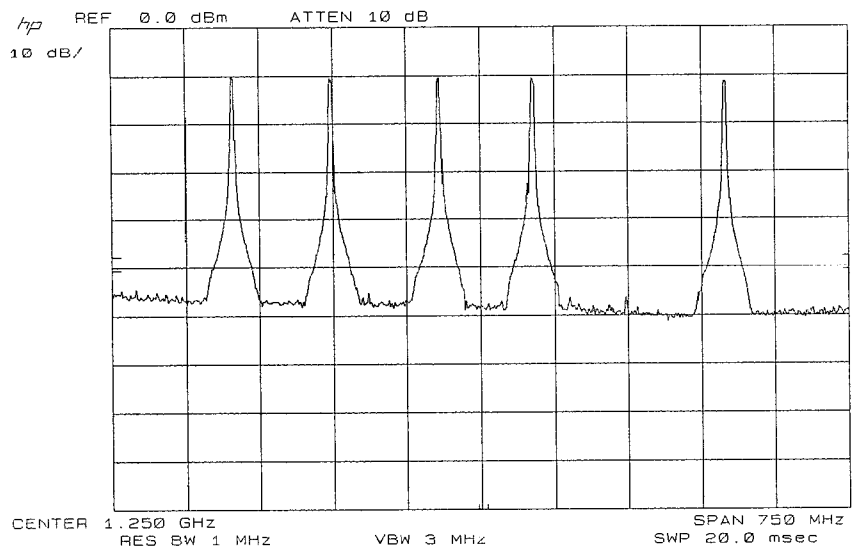

Figure 2-9. Frequency Hopping Radar

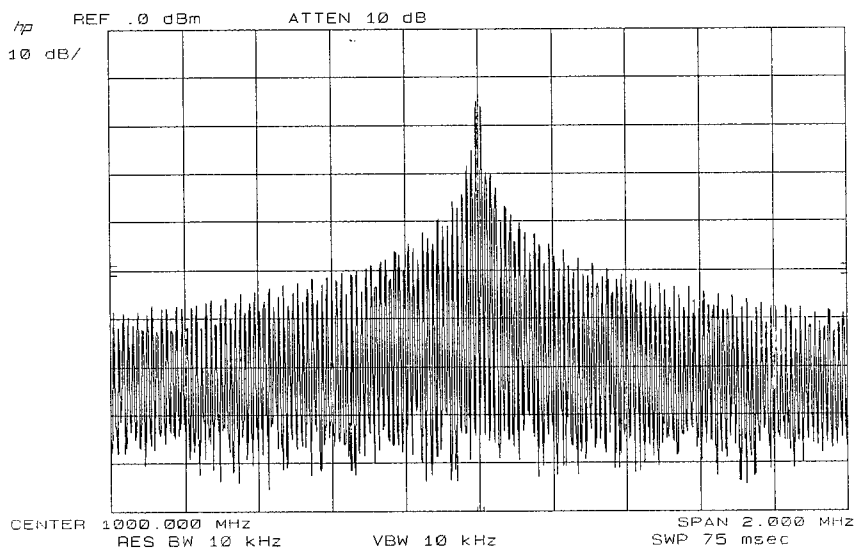

Figure 2-10. Individual Frequency Hop Radar Pulse

User Patterns

User patterns are ASCII text files that are used by IDs to customize an application. PSID uses user patterns for modulation waveforms for AM, FM, and PM. In addition, a user pattern is used to select frequencies for frequency hopping.

User patterns can be created by any application that can write an ASCII file. An ASCII text editor is included as part of SID. You can create user patterns using WGL. However, you can also use a spreadsheet application or a general purpose language such as BASIC to generate user patterns.

Because the PSID software is organized into two major subsystems (SID and PSID), the information on installing and removing user patterns is presented in chapter 3, "SID Local Operation" and the PSID application-specific user pattern information is presented in this chapter.

User Pattern Characteristics

A user pattern is a list of real numbers. The list can contain from 2 to 8193 real numbers. The first number in the list indicates the number of user entries in the list. The remaining entries are actual user pattern elements. Extra entries are ignored. There must be a carriage return after each element, including the last number in the list.

The following shows an example of a user pattern.

```
4
100e3
1.75e5
19995
100e3
```

Once a user pattern has been created, it must be installed on the removable cartridge before it can be used by PSID. For more information, see the User

Patterns ... command in the Utilities menu in chapter 3, "SID Local Operation."

After a user pattern has been created and installed on the removable cartridge, it can be used by PSID. Select the **USER** parameter of the **Mod. Waveform** command for the desired modulation function. (You can select a different pattern for each modulation function.) A dialog box is opened. You then select a user pattern name from the list of installed user patterns.

If you use a user pattern with a function for which it was not designed, the results can be unpredictable. The user functionality is controlled by the user pattern and the selected function's interpretation of the pattern data.

User pattern data is reloaded into the application from the removable cartridge after reentering the user pattern name or entering a new user pattern name. This method of handling the user pattern data is useful if a new or replacement user pattern is reinstalled on the removable cartridge.

PSID Data Scaling

AM

For AM user patterns, the user pattern is first normalized such that the absolute value is scaled to 1. The user pattern is then scaled by the AM depth selected from the PSID front panel. The halfway point between the minimum and maximum entries in the user pattern corresponds to the unmodulated carrier level.

FM and PM

For FM and PM user patterns, all of the data in the pattern is divided by the pattern's peak magnitude and then multiplied by the peak deviation set in PSID.

For example, given a user pattern containing data ranging from -10.5 to 5 , PSID would use 10.5 as the

peak magnitude. For PM, with a deviation of 45 degrees this pattern would result in a signal that has a phase deviation that ranges from -45 degrees to 21.4 degrees. For FM, with a peak deviation of 6 kHz this pattern would result in a signal that has a frequency deviation that ranges from -6 kHz to 2.857 kHz.

Freq Hop

For Frequency Hop user patterns, the data is not scaled. PSID treats entries in a user pattern as the exact carrier frequency to be output.

PSID Data Compression and Expansion

The effective sample rate or dwell time for each entry in a user pattern is determined by the modulation frequency set in PSID for that modulation format. If the modulation period (reciprocal of the modulation frequency) is not exactly equal to the sample period (reciprocal of the memory clock rate) multiplied by the number of elements in the user pattern, PSID uses compression, data expansion, or clock rate dividers to achieve the closest modulation frequency HP FASS can produce.

For best signal fidelity, try to avoid expansion and compression so that each entry in a user pattern is output once per memory clock cycle. To do this, use the following equation to calculate the modulation frequency that should be selected in PSID:

$$\text{ModulationFrequency} = \frac{\text{MemoryClock}}{\text{NumberOfElements}}$$

where *Memory Clock* = 2^{27} Hz (≈ 134 MHz) for AM and PM memories, and 2^{25} (≈ 33 MHz) for FM.

PSID automatically rounds the entered modulation frequency to the exact value it can produce (namely, a period that is an integer multiple of the memory clock period).

Compression

Compression is used when the modulation period is too short to accommodate all the user pattern entries.

Expansion

Expansion is used when there is not enough data to fill the modulation period. New data is generated between user pattern entries using one of the following expansion techniques:

- **Linear Interpolation**

This type of expansion is used when the new elements values should vary linearly between entries in a user pattern (for example, user patterns with linear shapes, such as ramps and random noise functions).

- **Sample and Hold**

This type of expansion is used when the new element's values should be set equal to the preceding user pattern entry (for example, user patterns representing discrete states - as in unfiltered digital modulation schemes like FSK and QPSK).

- **Cubic Spline**

This type of expansion is a third-order, curve-fitting algorithm. This filtering technique should be used with user patterns containing non-linear continuous functions, such as sine waves or quadratic functions.

When using cubic spline expansion, the lower limit on the modulation frequency is 0.126 Hz. Clock rate dividers are used for frequencies below 16.384 kHz for AM and PM, and below 4.096 kHz for FM.

Clock Rate Dividers

Below a certain modulation frequency (16.384 kHz in the AM memory), the clock rate divider is used. This is effectively the same as sample and hold expansion.

Even with linear or cubic spline interpolation, data will be stepped - resulting in distorted signals. For more information about using the rate divider, see Product Note 8791-3 *Theory of Operation for the HP 8791 Models 7/10/11/21 Frequency Agile Signal Simulator*.

User Patterns Shipped with PSID

When PSID is shipped from the factory, four user patterns are installed on the removable cartridge.

Table 2-2. User Patterns Shipped with PSID

Pattern Name	Recommended Modulation Type	Recommended Expansion Mode
gs_noise.usr (Gaussian noise)	AM	Interpolate
hop.usr	FREQ HOP	None
qpsk.usr	PM	Sample and Hold
triangle.usr	AM, FM	Interpolate

How to Edit an Existing User Pattern

User patterns installed on the removable cartridge can be edited from SID. User patterns are stored in the directory C:\USR\PATTERNS.

Note



User patterns saved on a floppy disk should be stored in a directory named PATTERNS. User Pattern commands, such as **Install Pattern from Floppy...** only recognize files stored in the PATTERNS directory.

To edit a user pattern:

1. Select **SID**, located near the top of the screen.
2. In the Utilities pull-down menu, select User Patterns ...

3. In the User Patterns dialog box, click on the name of the pattern you want to edit and select **Edit**.

The user pattern file will appear in the ASCII text editor with cursor positioned at the end of the file. (To move the cursor to the top of the file, press **Ctrl** + **Home** on the keyboard.)

How to Use WGL to Create a User Pattern

Note



You can use WGL or the built-in ASCII text editor to create, modify and display text files.

User patterns can only be modified from SID or WGL.

The following procedure shows how to use WGL to create triangular user pattern, similar to the one shipped with PSID. This procedure also shows how to save the data to a file.

To create a new user pattern, perform the following steps:

1. Select **WrkStn** on the toggle ribbon.
2. Type the following commands into the WGL command line. (The WGL command line is the rectangular box next to the WGL> prompt at the bottom of the WGL Command Log.)

```
2048 CTX Enter  
TDOMAIN Enter  
0 1023 WI Enter  
0 1 RAMP3? Enter  
1024 2047 WI Enter  
1 0 RAMP3? Enter
```

3. Type FULL? in the WGL command line. This displays the user pattern that was just created in the WGL Working Wave (Figure 2-11).

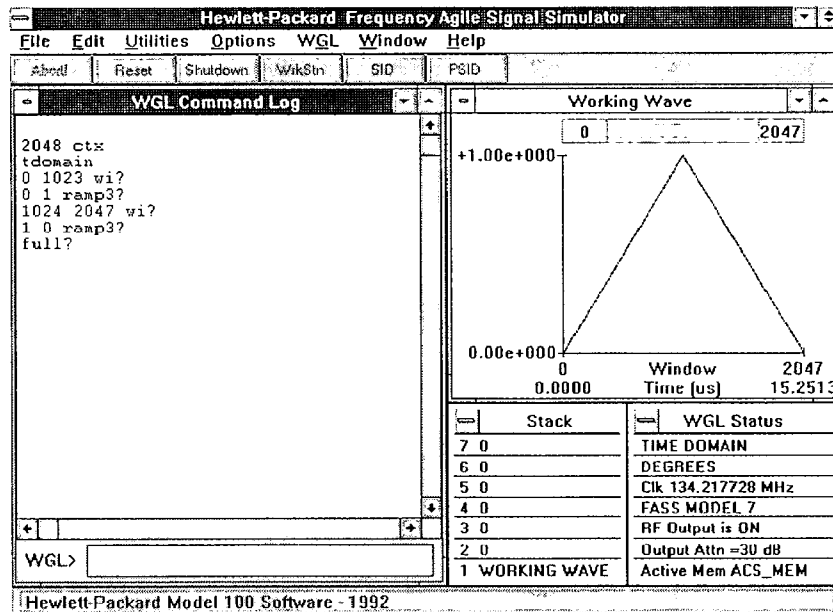

Figure 2-11. User Pattern Created in WGL

4. Type LOADPAT in the WGL command line.
5. Enter MYPAT.USR in the dialog box (Figure 2-12) to save the user pattern to a file and load it onto the removable cartridge.

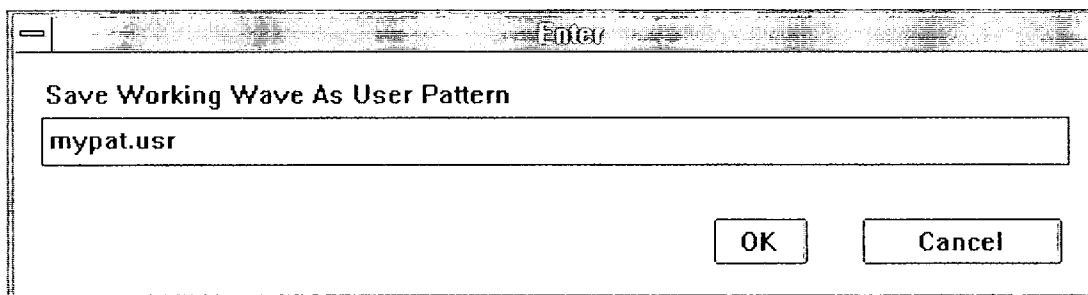

Figure 2-12. Load Pattern Dialog Box

2-22 PSID Local Operation

6. Type `CATPAT` in the WGL command line. This lists the user patterns that are installed on the removable cartridge in the WGL Command Log. Verify the `MYPAT.USR` is displayed.

This page is intentionally left blank.

Carrier Parameters

The carrier operates in two modes: constant or hopped. Hopped carrier signals are described under **FREQ HOP**, later in this section.

Four parameters define a constant carrier signal:

- Frequency
- Frequency Offset
- Amplitude
- Phase Offset

For HP FASS Models 11 and 21 that have been level calibrated, CW mode signals are corrected for amplitude flatness. This allows the AM function to be fully independent from the frequency hopping function.

Frequency

This command sets the output carrier frequency for non-hopped signals.

The range for carrier frequency is 0 Hz to 200 GHz in 0.125 Hz steps. However, the carrier frequency minus the frequency offset must be within the following range:

- HP FASS Model 7: 0 Hz to 67 MHz.
- HP FASS Model 11: 2 MHz to 3.05 GHz.
- HP FASS Model 21: 10 MHz to 19 GHz.

The equivalent HP-IB command is `:SOUR:FREQ:CW` (*Frequency Subsystem*).

Frequency Offset

This command sets the frequency offset. The frequency offset is subtracted from the carrier frequency to determine the frequency that HP FASS must generate.

The Frequency Offset command makes it easier to use HP FASS and PSID with an external upconverter.

The range for frequency offset is -200 GHz to $+200$ GHz in 0.125 Hz steps. However, the carrier frequency minus the frequency offset must be within the following range:

- HP FASS Model 7: 0 Hz to 67 MHz.
- HP FASS Model 11: 2 MHz to 3.05 GHz.
- HP FASS Model 21: 10 MHz to 19 GHz.

The equivalent HP-IB command is :SOUR:FREQ:OFFS
(*Frequency Subsystem*).

Amplitude

This command sets the amplitude of the unmodulated carrier.

When AM is active, the maximum carrier amplitude decreases as the AM depth increases, due to the limitation of the peak envelope to +10 dBm maximum. Thus for AM, at 100% depth the maximum carrier amplitude is reduced to 3.97 dBm, while at 500% depth it is reduced to -5.56 dBm.

The amplitude ranges are as follows:

- HP FASS Model 7: -100 to +10 dBm.
- HP FASS Model 11: -107 to +22 dBm.
- HP FASS Model 21: -100 to +10 dBm.

The equivalent HP-IB command is :SOUR:GLOB:AMPL
(*Global Subsystem*).

Phase Offset

This command sets the carrier phase offset.

Phase offset is used to adjust the phase of the carrier signal relative to another HP FASS. This command is useful when trying to eliminate phase skew between two or more synchronized HP FASS systems.

The range for phase offset is -180° to $+180^\circ$.

The equivalent HP-IB command is :SOUR:GLOB:PHAS
(*Global Subsystem*).

Modulation Parameters

PSID provides the following modulation capabilities:

- Amplitude Modulation (AM).
- Frequency Modulation (FM).
- Phase Modulation (PM).

In addition, the carrier frequency can be hopped.

Each type of modulation requires four parameters:

- Mod Rate - the modulation frequency.
- Mod Level - modulation depth for AM; frequency deviation for FM; peak deviation for PM.
- Mod Waveform - the modulating function.
- Delay - phase delay.

Frequency hopping requires two parameters:

- Mode Rate - the dwell time for the hop frequencies.
- Mod Waveform - a use-defined waveform to specify the hop frequencies.

AM

- Mod Rate** This command sets the modulation frequency for AM.
- The limits on the frequency of the modulating waveform are determined by the bandwidth of HP FASS. For a sine wave, a modulation frequency higher than 20 MHz doesn't make sense because of the 40 MHz HP FASS bandwidth limit. The frequency resolution of AM modulation varies with frequency. For sine waves, the resolution will always be better than 0.1%.
- The range for modulation frequency is 0.0625 Hz to 20 MHz. For a user pattern with cubic spline expansion, the lower limit on modulation frequency is 0.126 Hz.
- The equivalent HP-IB command is
:SOUR:AM:INT:FREQ (*Amplitude Modulation Subsystem*).
- Mod Level** This command sets the modulation depth for AM.
- When the AM function is active, the maximum carrier amplitude decreases as the AM depth increases, due to the limitation of the peak envelope to +10 dBm maximum. Thus, for AM modulation, at 100% depth the maximum carrier amplitude is reduced to 3.97 dBm, while at 500% depth it is reduced to -5.56 dBm.
- When user pattern modulation is used, modulation depth is used to scale the pattern to achieve the desired depth.
- The range for modulation depth is 0% (no modulation) to $\geq 500000\%$ (infinite depth).
- Double-sideband suppressed-carrier (DSB-SC) signals may be generated by using a depth of 500000%.

The equivalent HP-IB command is :SOUR:AM:DEPT
(*Amplitude Modulation Subsystem*).

Mod Waveform

This command selects the modulation waveform for AM.
The AM Mod Waveform parameters are as follows:

Parameter	Description
Sine	Modulating signal is a sine wave.
User	Modulating signal is a user-defined waveform. The modulation frequency determines how often the pattern repeats. No scaling is required. PSID automatically adjusts the pattern data to achieve the desired modulation depth and rate.
Rectangular	Modulating signal is a rectangular waveform.

The equivalent HP-IB command is
:SOUR:AM:INT:FUNC (*Amplitude Modulation Subsystem*).

Rectangular

A rectangular waveform requires one additional parameter: duty cycle. The duty cycle is the percent of the modulation period that the waveform is pulsed on.

The range for duty cycle is 0 to 100%, but varies with the modulation frequency. For frequencies less than 4 kHz, the minimum duty cycle is 0.012% and the maximum duty cycle is 99.988%. For frequencies greater than 4 kHz, the minimum duty cycle is $100(\text{frequency}/(\text{clock_frequency}/4))$. The maximum duty cycle is determined by $100\% - \text{minimum duty cycle}$.

The carrier level entered and displayed is the carrier level before modulation is applied.

The equivalent HP-IB command for duty cycle is :SOUR:AM:INT:DCYC (*Amplitude Modulation Subsystem*).

User Pattern

Selecting USER in the Mod Waveform list box opens the AM Waveform dialog box (Figure 2-13).

An AM user pattern requires two additional parameters:

- User pattern name.
- User pattern expansion mode.

A user pattern must be installed on the removable cartridge before it can be used. For more information about installing user patterns on the removable cartridge, see the User Patterns ... command in the Utilities pull-down menu, described in chapter 3. The dialog box lists the currently installed patterns.

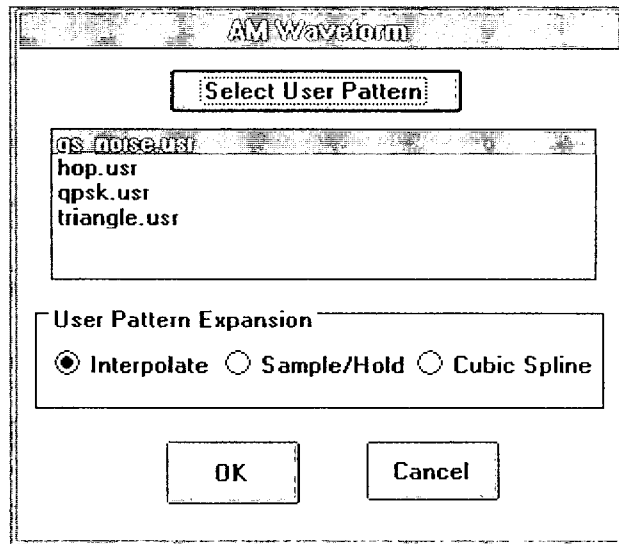

Figure 2-13. AM Waveform Dialog Box

The User Pattern Expansion parameter selects how the user pattern will be expanded. Three expansion modes are available:

- Interpolate - the new element's value varies linearly between entries.
- Sample/Hold - the new element's value is set equal to the preceding user pattern entry.
- Cubic Spline - a third-order, curve-fitting algorithm for user patterns containing non-linear continuous functions.

See "User Patterns" in the beginning of this chapter for more information about expansion modes.

To select a user pattern and the expansion mode:

1. Click on the pattern you want to use from the list of currently installed user patterns.

2. Select .
3. Select Interpolate, Sample/Hold or Cubic Spline.
4. Select to close the dialog box.

The equivalent HP-IB command for is :SOUR:AM:INT:USER:NAME (*Amplitude Modulation Subsystem*).

The equivalent HP-IB command for expansion mode is :SOUR:AM:INT:USER:MODE (*Amplitude Modulation Subsystem*).

Delay

This command sets the delay time of the signal relative to the carrier. Delay is a relative phase shift of the modulating signal with respect to the carrier, not a delay until modulation begins.

The delay is specified in seconds. The delay can range from 0 to one period of the modulating waveform. Setting the delay for a length of time longer than the modulating waveform's period will result in a delay equal to the remainder of the requested delay divided by the function's period.

Resolution of the delay is determined by the address rate divider setting for the AM sequencer. The address rate divider setting depends on the frequency of the modulating function. As a result, the delay resolution is determined by the frequency of the modulating function.

Delay is useful when the phase relationship between two different types of modulation is important. An example of a case where delay is necessary is QAM. QAM requires careful synchronization between PM and AM.

The range for delay is 0 to 16 seconds.

The equivalent HP-IB command is :SOUR:AM:DEL (*Amplitude Modulation Subsystem*).

FM

Mod Rate This command sets the modulation frequency for FM. To keep spurious signals lower than 40 dB below the unmodulated carrier, the modulation frequency is approximately limited as follows:

$$\text{modulation_frequency} \leq (10 - 4.8(\text{peak_deviation}^{0.25})),$$

where *modulation_frequency*, *peak_deviation* are in MHz. For example, with a peak deviation of 1 MHz, the modulation frequency should be limited to 5.2 MHz. The frequency resolution of the modulation waveform varies with its frequency and modulating function. The range modulation frequency is 0.0625 Hz to 20 MHz (for sine waveforms). For user patterns with cubic spline expansion, the lower limit on modulation frequency is 0.126 Hz. The equivalent HP-IB command is :SOUR:FM:INT:FREQ (*Frequency Modulation Subsystem*).

Mod Level This command sets the peak deviation for FM. To keep spurious signals lower than 40 dB below the unmodulated carrier, the relationship between the modulation frequency and peak deviation must satisfy the following equation:

$$\text{modulation_frequency} \leq (10 - 4.8(\text{peak_deviation}^{0.25})),$$

where *modulation_frequency*, *peak_deviation* are in MHz. For example, at the lowest allowed modulation frequency, 0.0625 Hz, the maximum peak deviation to meet this requirement would be approximately 18.8 MHz. For a

peak deviation of 1 MHz, the modulation frequency should be limited to approximately 5.2 MHz.

The peak deviation value is used to scale the FM user patterns. The user pattern is scaled so that its peak magnitude corresponds to the peak deviation.

The range for peak deviation is 0 Hz to 67 MHz. However, the 40 MHz bandwidth of HP FASS is ultimately the limiting factor for peak deviation of FM signals.

The equivalent HP-IB command is :SOUR:FM:DEV (*Frequency Modulation Subsystem*).

Mod Waveform

This command sets the FM modulation waveform.

The FM Mod Waveform parameters are as follows:

Parameter	Description
Sine	Modulating signal is a sine wave.
User	Modulating signal is a user-defined waveform. User patterns are scaled about zero such that the peak value of the user pattern corresponds to the peak deviation.

The equivalent HP-IB command is :SOUR:FM:INT:FUNC (*Frequency Modulation Subsystem*).

User Pattern

Selecting USER in the Waveform list box opens the FM Waveform dialog box (Figure 2-14).

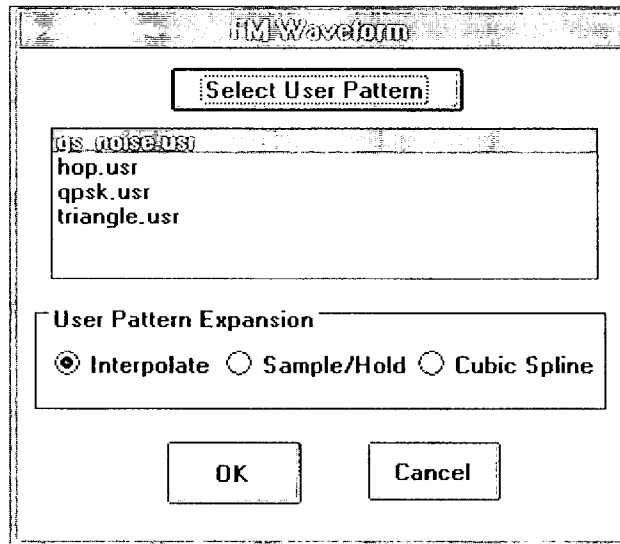

Figure 2-14. FM Waveform Dialog Box

A user pattern requires two additional parameters:

- User pattern name.
- User pattern expansion mode.

A user pattern must be installed on the removable cartridge before it can be used. For more information about installing user patterns on the removable cartridge, see the `User Patterns ...` command in the Utilities pull-down menu, described in chapter 3. The dialog box lists the currently installed patterns.

The User Pattern Expansion parameter selects how the user pattern will be expanded. Three expansion modes are available:

- Interpolate - the new element's value varies linearly between entries.
- Sample/Hold - the new element's value is set equal to the preceding user pattern entry.

- Cubic Spline - a third-order, curve-fitting algorithm for user patterns containing non-linear continuous functions.

See “User Patterns” in the beginning of this chapter for more information about expansion modes.

To select a user pattern and the expansion mode:

1. Click on the pattern you want to use from the list of currently installed user patterns.
2. Select .
3. Select Interpolate, Sample/Hold or Cubic Spline.
4. Select to close the dialog box.

The equivalent HP-IB command for is :SOUR:FM:INT:USER:NAME (*Frequency Modulation Subsystem*).

The equivalent HP-IB command for expansion mode is :SOUR:FM:INT:USER:MODE (*Frequency Modulation Subsystem*).

Delay

This command sets the delay time of the signal relative to the carrier. Delay is a relative phase shift of the modulating signal with respect to the carrier, not a delay until modulation begins.

The delay time can range from 0 to one period of the modulating function. Setting the delay to a time longer than the modulating waveform’s period results in a delay equal to the remainder of the desired delay divided by the period of the modulating waveform.

The range for delay is 0 to 16 seconds.

The equivalent HP-IB command is :SOUR:FM:DEL (*Frequency Modulation Subsystem*).

PM

Mod Rate This command sets the modulation frequency for PM.

The limits on the frequency of the modulating waveform depend on the function itself. The actual limit on phase modulation is the 40 MHz HP FASS bandwidth. 10 MHz is a reasonable limit for small deviations.

The range for modulation frequency is 0.0625 Hz to 20 MHz. For user patterns using cubic spline expansion, the lower limit on modulation frequency is 0.126 Hz.

Mod Level This command sets the peak deviation for PM.

If the selected modulation waveform is USER, the peak deviation is used to scale the user pattern data. The user pattern is scaled so that its peak magnitude corresponds to the peak deviation.

The range for peak deviation is 0 to 180°.

Mod Waveform This command selects the modulation waveform for PM.

The PM Mod Waveform parameters are as follows:

Parameter	Description
Sine	Modulating signal is a sine wave.
User	Modulating signal is a user-defined waveform. User patterns are scaled about zero such that the peak value of the user pattern corresponds to the peak deviation.

The equivalent HP-IB command is
:SOUR:PM:INT:FUNC (*Phase Modulation Subsystem*).

User Pattern

Selecting USER in the Waveform list box opens the PM Waveform dialog box (Figure 2-15).

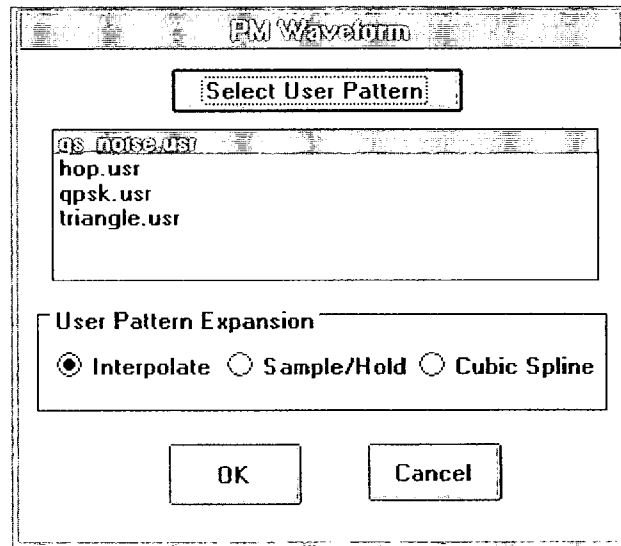

Figure 2-15. PM Waveform Dialog Box

User patterns require two additional parameters:

- User pattern name.
- User pattern expansion mode.

A user pattern must be installed on the removable cartridge before it can be used. For more information about installing user patterns on the removable cartridge, see the `User Patterns ...` command in the Utilities pull-down menu, described in chapter 3. The dialog box lists the currently installed patterns.

The User Pattern Expansion parameter selects how the user pattern will be expanded. Three expansion modes are available:

- Interpolate - the new element's value varies linearly between entries.
- Sample/Hold - the new element's value is set equal to the preceding user pattern entry.
- Cubic Spline - a third-order, curve-fitting algorithm for user patterns containing non-linear continuous functions.

See "User Patterns" in the beginning of this chapter for more information about expansion modes.

To select a user pattern and the expansion mode:

1. Click on the pattern you want to use from the list of currently installed user patterns.
2. Select .
3. Select Interpolate, Sample/Hold, or Cubic Spline.
4. Select to close the dialog box.

The equivalent HP-IB command for is `:SOUR:PM:INT:USER:NAME` (*Phase Modulation Subsystem*).

The equivalent HP-IB command for expansion mode is `:SOUR:PM:INT:USER:MODE` (*Phase Modulation Subsystem*).

Delay

This parameter sets the delay time of the signal relative to the carrier. Delay is a relative phase shift of the modulating signal with respect to the carrier, not a delay until modulation begins.

The delay time can range from 0 to one period of the modulation waveform. Setting delay to a time longer than the period of the modulation waveform will result in a delay equal to the remainder of the desired delay divided by the period of the modulation waveform.

The range for delay is 0 to 16 seconds.

The equivalent HP-IB command is :SOUR:PM:DEL
(*Phase Modulation Subsystem*).

FREQ HOP

The carrier frequency can operate in one of two modes: constant or hopped.

Hopped carrier signals require a user pattern to indicate the output frequencies.

The following parameters are used to define a hopped carrier signal:

- Carrier Frequency Offset
- Carrier Amplitude
- Carrier Phase Offset
- Freq Hop Mod Rate (Dwell Time)
- Freq Hop Mod Waveform (User)

Carrier frequency offset, amplitude, and phase are described under the Carrier Signal in this chapter.

Note



When frequency hopping, PSID does not account for the AUC settling, in part because PSID frequency hopping is not pulsed. If you want a pulsed hopped signal that minimizes the settling time, in some situations it may be possible to use AM rectangular modulation with 100% depth and use delay to position the settling during the AM off-time.

Mode Rate

This command sets the dwell time for the frequencies in the user hop pattern. The dwell time specifies how long each frequency is output.

Frequency hop patterns may be up to 16 seconds in length and have up to 8192 frequencies. For patterns with greater than 2048 frequencies, actual dwell times above 1.95 ms are limited, depending on the actual number of frequencies. The relationship is as follows:

Number of Frequencies		Maximum Dwell Time
Greater Than	Less Than or Equal to	
2048	2730	5.86 ms
2730	4096	3.91 ms
4096	8192	1.95 ms

For dwell times less than 1.95 ms, the dwell time resolution is 120 nanoseconds. In general, dwell time resolution is $\leq 0.1\%$.

The range for dwell time is 120 ns to 16 seconds.

The equivalent HP-IB command is
`:SOUR:FREQ:HOP:DWEL` (*Frequency Subsystem*).

Mod Waveform

This command selects the user pattern to be used for frequency hopping.

The frequency hop user pattern is not scaled. The numbers in the pattern file are assumed to indicate the actual frequencies to use.

Selecting USER in the Waveform list box opens the Freq Hop Waveform dialog box (Figure 2-16).

A user pattern must be installed on the removable cartridge before it can be used. For more information about installing user patterns on the removable cartridge, see the `User Patterns ...` command in the Utilities pull-down menu, described in chapter 3. The dialog box lists the currently installed patterns.

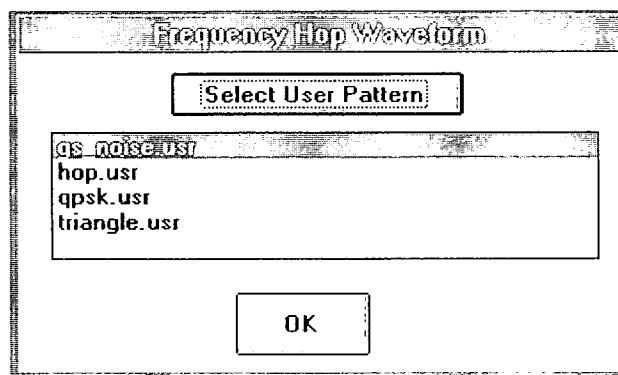

Figure 2-16. Frequency Hop Waveform Dialog Box

To select a user pattern for frequency hopping:

1. Click on the pattern you want to use from the list of currently installed user patterns..
2. Select **Select User Pattern**.
3. Select **OK** to close the dialog box.

The equivalent HP-IB command for **Select User Pattern** is `:SOUR:FREQ:HOP:USER:NAME` (*Frequency Subsystem*).

Run

This command generates a signal based on the current PSID software settings. If external triggering is enabled, the waveform will be set up and awaiting a trigger after RUN has been executed.

A red check at the bottom right of the screen indicates that the PSID software settings have not changed since the last time **Run** was issued.

The equivalent HP-IB command is :SOUR:GLOB:RUN (*Global Subsystem*).

SID Local Operation

Introduction

Local operation of the System ID (SID) functions consists of using commands in SID screens and pull-down menus to control the operation of the HP FASS system. Using these commands is sometimes referred to as front-panel operation.

Operating HP FASS typically involves performing the following tasks:

- Configuring the system.
- Defining signals.
- Generating signals.

SID has three screens: the SID Control Panel, SID Extended Control Panel, and SID Event Markers. These screens are used for configuring HP FASS. In addition, most of the commands in the Utilities and Options menus are used for system configuration or data management.

Defining signals consists of loading data into the modulation memories and creating sequences to determine the order in which the data will be accessed. To define signals from the front panel you must use WGL (Waveform Generation Language). WGL is a full-featured macro language that resides on the Smart Interface. It is accessed from the WGL menu, the **Wrkstn** button, or from icons at the bottom of the SID Control Panel. Optional IDs, such as RSID and PSID, can also be used to define signals from the front panel.

Signals can be generated by several methods, including using the **Signal Control** command in the Utilities menu or by using the System Triggering connectors on the rear panel of the MDS.

Chapter Contents

The following information is contained in this chapter:

- An overview of the SID front panel.
- Descriptions of the SID screens and their associated commands.
- Descriptions of the pull-down menus and their associated commands.

The SID screens are described in the following order:

- SID Control Panel
- SID Extended Control Panel
- SID Event Markers

The commands on each screen are described in alphabetical order.

Menus are described in the order they appear on the menu bar. The commands on each menu are also described in the order in which they appear.

Note



Much of the technical information about HP FASS is located in the *Remote Operation Reference*, particularly the FASS Subsystem chapter. The equivalent HP-IB command is included in the description of each command, where applicable. If you want additional technical information about a command, see the equivalent HP-IB command.

SID Front Panel Overview

The SID front panel consists of one main screen, the SID Control Panel, and two other screens that are accessed from the SID Control Panel. Each screen has several commands.

There are seven pull-down menus at the top of the screen. Each menu contains several commands.

SID front panel operation consists of using the commands on the screens and in the menus to control HP FASS.

Figure 3-1 shows the different areas of the SID Control Panel front panel.

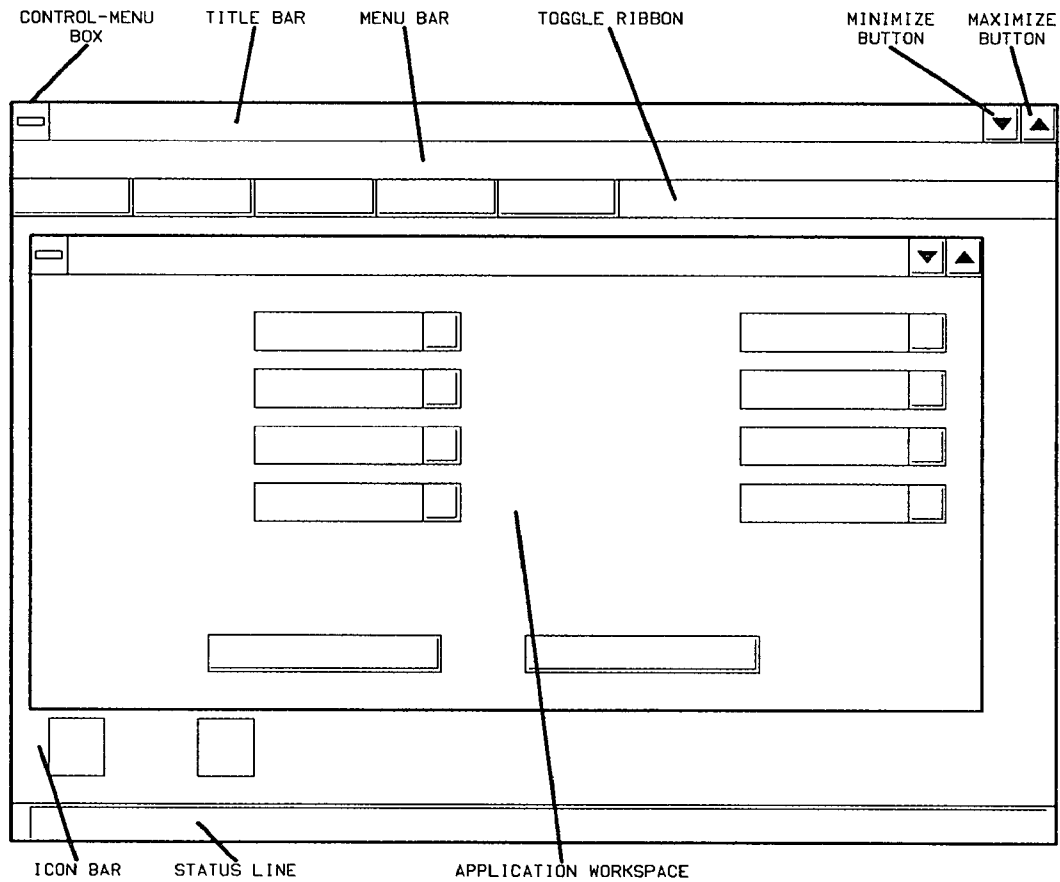

Figure 3-1. SID Front Panel

The SID front panel is divided into the following areas:

- Control-Menu Box - Opens the Control menu. Control menu commands move, change the size of, and close windows.

To close a window, double-click on this box.

- Title Bar - Displays the name of the application.
- Minimize Button - Shrinks the window to an icon.

3-4 SID Local Operation

- Maximize Button - Expands the window to fill the entire screen.
- Menu Bar - Contains the names of the pull down menus that are available. Each menu contains commands that you can use.
- Toggle Ribbon - Provides easy access to frequently used commands.
- Application Workspace - Displays the SID screens, which contain command buttons to control SID operations.
- Icon Bar - Contains graphic symbols that represent SID and WGL features.

To restore one of these features, double-click on the icon.
- Status Line - Displays information about the system status, including error messages.

Command Types

Commands on the SID screens can be one of several types:

- Pushbutton - indicated by a rounded corner rectangle with text inside. When this command is selected, its function is implemented immediately. A command name that is followed by three dots opens a dialog box. A dialog box prompts you for more information before implementing the command.
- Drop down list box - a rectangular box with a down arrow to the right and the current selection highlighted in the box. Clicking on the arrow opens the list of available choices. Click on one of the choices to select it.
- Option buttons - round buttons that provide a list of mutually exclusive items. You can select only one

option from the group at a time. The selected option button contains a black dot.

- Text box - a rectangle into which you type information.

Many of these command types also appear in dialog boxes.

Pull-Down Menus

When you click on a menu, a list of commands is displayed under the menu. To select a command, click on the command name. To close a menu, click anywhere outside the menu.

The pull-down menus have two types of commands: commands that are implemented immediately and commands that open a dialog box. Like the command types on the SID screens, a command name that is followed by three dots opens a dialog box.

Some menu commands are only available under certain conditions. When a command is not available, it is grayed out.

Several pull-down menu commands can be activated from the keyboard if you don't want to use a mouse. For example, the Signal Control box can be displayed by pressing the **Ctrl** and **T** keys simultaneously. Available keyboard shortcuts are listed in the pull-down menu next to the command.

Dialog Boxes

When you select a command that is followed by three dots, a dialog box is opened. A dialog box requests additional information that is required to implement the command. While a dialog box is open, you cannot access the pull-down menus and their associated commands.

Typically, you close a dialog box by selecting **OK** or **Cancel**. **OK** causes the application to accept any changed information in the dialog box. **Cancel** closes

the dialog box without making any changes to the application.

Anytime a command button is outlined in bold, you can activate that choice by pressing **Enter** on the keyboard.

Toggle Ribbon

The toggle ribbon is a list of frequently used commands. These commands are displayed across the top of the screen for easy access. The toggle ribbon can be turned on or off by selecting the **Toggle Ribbon** command from the Options menu.

The toggle ribbon contains the following commands.

Abort!

Aborts the current action being performed by HP FASS. This command is used primarily to terminate functions that take a long time to implement, such as level calibration.

Reset

Resets HP FASS to default conditions. Identical to the **System Reset** command in the Utilities menu. See Table 3-2, located in the description of the Utilities pull-down menu later in the chapter, for a list of SID default conditions. See Table 2-1 in chapter 2 for a list of PSID default conditions.

Shutdown

Used prior to turning off the system to ensure the system will boot up with its current hardware and software settings. Identical to the **Shutdown** command in the Utilities menu.

System Busy Indicators

While HP FASS is performing some functions, additional input from the front panel is not accepted. HP FASS has several ways of indicating it is busy.

- **FASS Busy** indicator on the far right of the toggle ribbon lights when the hardware is busy.
- If no input from the front panel is allowed, the mouse pointer turns into an hourglass symbol until a function is completed.
- If input is allowed from some areas, such as the WGL Command Log, but not others, the mouse pointer turns into a black circle in areas where input is not allowed. The mouse pointer is displayed in areas where input is allowed.
- The status line displays a message regarding the system status.

The SID Environment (Windows)

SID uses a graphical user interface based on Microsoft® Windows, version 3.1. (Microsoft® is a U.S. registered trademark of Microsoft Corporation.)

If you are new to Windows, it is recommended that you run the online Windows tutorial.

Windows Tutorial

To run the online windows tutorial:

1. Click on the Help menu to display a list of commands.
2. Click on the **Windows Tutorial** command to start the tutorial.
3. Follow the instructions on the screen.

The tutorial is divided into two parts: basic mouse skills and Windows basics. You can perform either or both parts.

The following topics are covered in the basic mouse skills portion of the tutorial:

- Mouse techniques.
- Different parts of a window.

The following topics are covered in the Windows basics portion of the tutorial:

- Opening and closing applications.
- Sizing windows.
- Moving windows.
- Opening and closing menus.
- Selecting menu commands.
- Using dialog boxes.

Note



When shipped from the factory, HP FASS uses the leftmost button on the mouse. The Windows tutorial allows you to switch the functions of the left and right mouse buttons.

Program Manager

Program Manager is a Windows function that is always running in the background while you are using SID. In most cases, the fact that Program Manager is running is transparent. However, to perform the following SID functions, it is necessary to interact directly with the Program Manager:

- Formatting a 3.5 inch floppy disk.
- Installing a printer.

Note



The Program Manager icon may not be visible if the SID or WGL windows are maximized. To access Program Manager in this case, hold the **(Alt)** key down while pressing the **(Tab)** key repeatedly until a box that says Program Manager is displayed. Then release the **(Alt)** and **(Tab)** keys to display the Program Manager application.

Full Microsoft Windows functionality is available, but not supported, from SID. Online help is available for most Windows functions.

Note



If you accidentally close the Program Manager, type **WIN** at the DOS prompt to return to SID.

Screen Saver

If you have not been actively using SID for at least five minutes, a pattern is displayed on your screen. This is to save the screen. Press any key or move the mouse to return to the front panel display.

You can change the pattern and duration, or turn the screen saver off. Go to Program Manager and select Control Panel. From the Control Panel, select Desktop to make any changes.

Formatting a Floppy Disk

Hardware images, ID settings, user patterns, and WGL files can be saved on a floppy disk. However, the disk must first be formatted for MS-DOS®. (MS-DOS® is U.S. registered trademark of Microsoft Corporation.)

The disk drives in the Smart Interface use a non-standard physical configuration (see figure 3-3). As shown, the 3.5 inch floppy disk drive is defined as drive A.

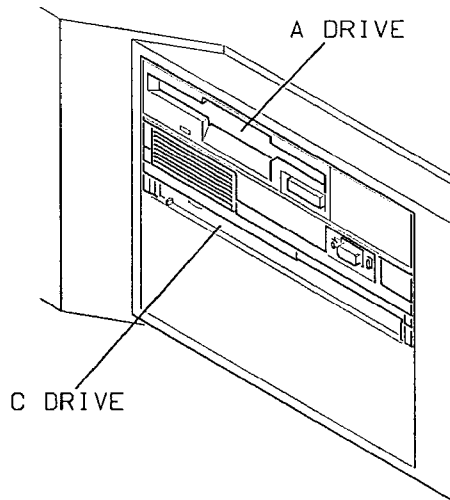

Figure 3-3. Disk Drive Physical Configuration

To format a disk for MS-DOS:

1. Insert a 3.5 inch high density 1.44 MByte floppy disk into drive A.
2. From SID, open the Program Manager application.
Hold down the **(Alt)** key while pressing the **(Tab)** key repeatedly until a box that says Program Manager is displayed. Then release the **(Alt)** and **(Tab)** keys to display the Program Manager application.
3. From Program Manager, double-click on the File Manager icon in the Main window.
4. In the File Manager menu bar, open the Disk menu and select the **Format Disk ...** command.
5. Fill out the requested information in the Format Disk dialog box. Press **(Help)** if you need additional information.
6. Exit File Manager by double-clicking on the control-menu box.

7. Use the **Alt** and **Tab** keys to return to SID.

To remove the disk from drive A, press the release button (see figure 3-4).

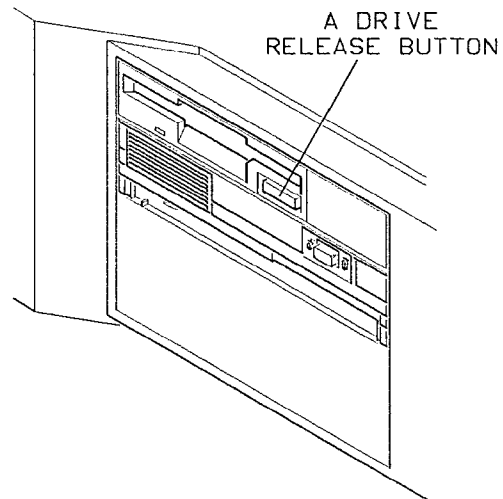

Figure 3-4. A Drive Release Button

Installing a Printer

SID supports the following printers:

- ▣ HP LaserJet family (PCL drivers).
- ▣ HP Plotter family (HPGL drivers).
- ▣ HP DeskJet family.
- ▣ HP PaintJet family.
- ▣ HP ThinkJet family.

Note



If you do not have one of the supported printers, you may still be able to print from SID if your printer is compatible with Microsoft Windows version 3.0 or greater. However, you will need to get the printer driver for your printer from either the Microsoft Windows disks (not supplied) or from your printer vendor.

Before printing from SID for the first time, you will need to install your printer in Microsoft Windows.

1. From SID, open the Program Manager application.

Hold down the **(Alt)** key while pressing the **(Tab)** key repeatedly until a box that says Program Manager is displayed. Then release the **(Alt)** and **(Tab)** keys to display the Program Manager application.

2. From Program Manager, double-click on the Control Panel icon in the Main window.
3. From the Control Panel, select Printers. Fill in the information in the window to install your printer. Press **(Help)** if you need additional information.
4. FOR SERIAL PORT PRINTERS ONLY: After you have installed your printer in the above step, select Ports from the Control Panel.
 - a. In the Ports window, select COM1 and **(Settings...)**.
 - b. Fill out the requested information in the Settings for COM1 window. Press **(Help)** if you need additional information.
5. Close the Control Panel by double-clicking on the control-menu box.
6. Use the **(Alt)** and **(Tab)** keys to return to SID.

The printer connects to the rear panel of the Smart Interface as shown in figure 3-5.

Note



See your printer manual for the correct cable part number.

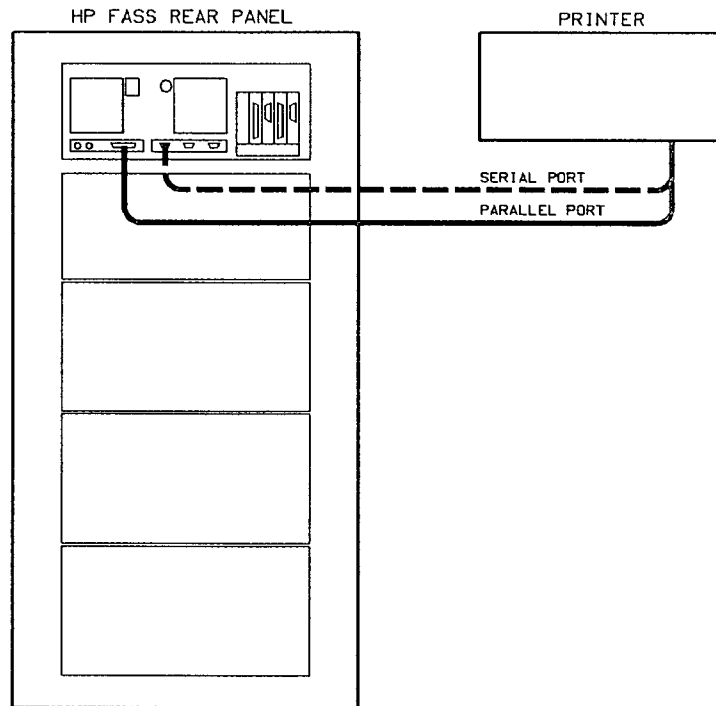

Figure 3-5. Connecting a Printer to the Smart Interface

This page is intentionally left blank.

SID Control Panel

The SID Control Panel is the main screen of HP FASS if an optional ID is not installed. Figure 3-6 shows the SID Control Panel.

SID Control Panel commands set global parameters that affect the entire system.

The current setting of a command is displayed in the rectangular box adjacent to the command name.

Except for the Attenuator, to change the setting of a command:

1. Click the arrow on the list box to the right of the command name.

A list of valid parameters drops down.

2. Select the parameter you want from the list.

The list closes and the current setting is displayed.

To change the Attenuator setting, you can click on the arrows next to the box until the desired setting is displayed. Or, you can type the desired setting into the box.

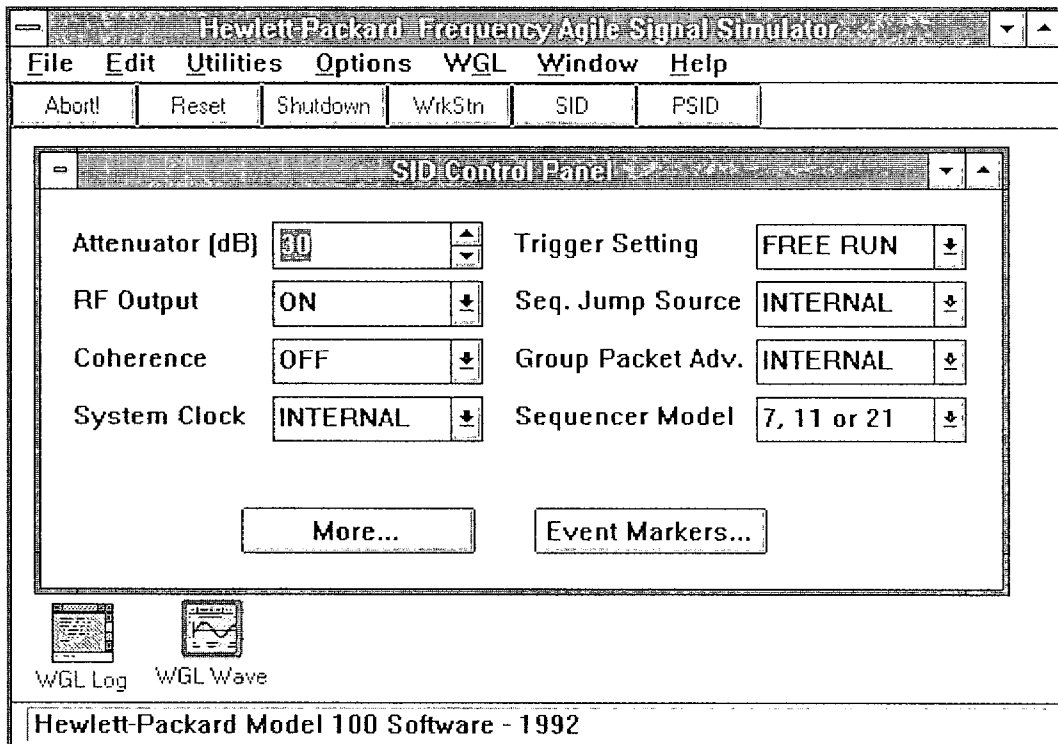

Figure 3-6. SID Control Panel

Attenuator

The command button sets the output attenuator. The default (reset) setting is 30 dB. You can change this setting to modify the RF output signal without executing an application run and recalculating data. This allows you to change the reference level of the output signals.

The attenuator parameters are as follows:

Hardware	Range
Model 7	0 to 110 dB in 10 dB steps.
Model 11	0 to 70 dB in 10 dB steps.
Model 21	0 to 121 dB in 1 dB steps.

For Model 21, you can get a level of +10 dBm by using special function 14.1 to change the AUC output attenuator to 0 dB (default is 10 dB).

The equivalent HP-IB command is :POW:ATT (*Power Subsystem*).

Coherence

This command selects the HP FASS phase coherence mode. In phase-coherent frequency switching, the signal appears as if each frequency were being generated by a separate, continuously-running oscillator that is being switched in and out as needed. Whenever HP FASS returns to a specific frequency, the phase of the output signal is as if the signal had always been at that frequency.

The default Coherence mode is Off.

The coherence parameters are as follows:

Parameter	Description
Off	No phase coherence. The phase is continuous and there are not discontinuities in the phase of the signal during switching.
Freq	Only frequency data is phase coherent.
FmFreq	Both FM and frequency data are phase coherent.

The equivalent HP-IB command is :FASS:PCOH (*FASS Subsystem*).

Event Markers . . .

This command activates the SID Event Markers dialog box.

Group Packet Adv.

This command selects the source for the group packet advance signal.

The Group Packet Advance parameters are as follows:

Parameters	Description
Internal	Sets the group packet advance source to internal. Packets can be advanced from the front panel with the WGL command GRPADV or from HP-IB with the :FASS:ASEQ GRO command.
External	Selects the GROUP SEQUENCE JUMP port on the MDS rear panel as the source of the group packet advance signal.

The equivalent HP-IB commands is :FASS:GADV (*FASS Subsystem*).

More ... This command activates the SID Extended Control Panel.

RF Output This command effectively turns the system's RF Output on or off. It turns the signal off by inserting 90 dB of attenuation and pulsing off the signal. The signal returns to its previous settings when it is turned on.

The parameters for this command are the following:

Parameter	Description
On	Turns RF output on.
Off	Turns RF output off.

The equivalent HP-IB commands are :POW:ON and :POW:OFF (*Power Subsystem*).

Seq. Jump Source This command selects a source for the group sequence jump signal. The group sequence jump signal is the trigger that causes the current sequence to jump to the next sequence.

The Sequence Jump Source parameters are as follows:

Parameters	Description
Internal	Sets the group jump source to internal and executes a sequence jump.
External	Selects the GROUP SEQUENCE JUMP port on the MDS rear panel as the group jump source.

The equivalent HP-IB commands is :FASS:SEQ:JUMP (*FASS Subsystem*).

System Clock

This command selects the clock source for the HP FASS system.

The default value of the System Clock is internal. The internal clock is the 134.2177282 MHz

The clock (either internal or external) is connected to the EXT CLK INPUT rear panel connector of the Agile Carrier Synthesizer (ACS). When the external clock is used, system software calculations are based on the frequency that is entered when the clock is switched to external. If the wrong frequency is entered, the calculations will be incorrect and errors will occur.

Resolution of the HP FASS system is 0.125 Hz when the internal clock is used and $\text{EXTERNAL CLOCK}/2^{30}$ when an external clock is used.

The System Clock parameters are as follows:

Parameter	Description
Internal	134.217728 MHz (2^{27})
External	The external clock is specified for 120 to 140 MHz but the system will accept 110 to 160 MHz for the external clock. The amplitude is specified at 0 to +10 dBm into 50 ohms. The wave shape is specified as a square wave to sine wave with approximately 50% duty cycle.

Note



If the System Clock is set to External (for Models 11 and 21), to return the system clock to internal, you must first reconnect the 134 MHz clock from the AUC to the ACS.

The equivalent HP-IB commands are :FASS:CINT and :FASS:CEXT (*FASS Subsystem*).

Sequencer Model

This command sets the system sequencer model. In Model 10, you are limited to one sequence, with a maximum of 2048 packets. In Model 7, 11, or 21, you are allowed up to 1024 different sequences and up to 32768 packets and loop packets.

The Sequencer Model parameters are as follows:

Parameters	Description
Model 10	Provided for porting programs and hardware images that were developed on Model 10 hardware over to Model 11 or 21 hardware.
Model 7, 11, or 21	Recommended for Model 7, 11, and 21 hardware.

The equivalent HP-IB commands is :FASS:SMOD (*FASS Subsystem*).

Trigger Setting

This command selects the trigger setting.

The default Trigger Setting is Free Run.

The Trigger Setting parameters are as follows:

Parameters	Description
Free Run	The sequence runs continuously. Free run mode does not require a triggered start.
Ext. Single	<p>External Single. The sequence is started with the Trigger command from the Signal Control dialog box, HP-IB, or an external TTL-level trigger to the SYSTEM START INPUT (on the MDS rear panel) and runs to the end of the sequence. The sequence then stops and waits for another trigger.</p> <p>In order for Ext. Single to function correctly, a cable must be connected from some sort of stop trigger to the SYSTEM STOP INPUT connector on the MDS rear panel. For example, one of the event markers could be connected to the SYSTEM STOP INPUT.</p>
Ext. Cont.	External Continuous. The sequence is started by the Trigger command from the Signal Control dialog box, HP-IB, or an external TTL-level trigger to the SYSTEM START INPUT (on the MDS rear panel) and then runs continuously.

The equivalent HP-IB commands is TRIG:INIT (*Trigger Subsystem*).

SID Extended Control Panel

The SID Extended Control Panel is accessed from the **More...** command on the SID Control Panel. These commands set parameters for the active memory (AMPM, PM, FM, and FREQ).

When a command is selected, the memory to which it applies automatically becomes the active memory.

After you have entered the desired data, select **OK** to return to the SID Control Panel. While the SID Extended Control Panel is open, the pull-down menus cannot be accessed

The screenshot shows the 'SID Extended Control Panel' window. At the top, there are four radio buttons for 'Active Memory': AMPM, PM, FM, and FREQ. The FREQ radio button is selected. Below this, there are four columns of controls corresponding to each memory mode. The first column (AMPM) has: Sequence Mode (OFF), Dynamic Data Mode (SYNC), Memory Address Out (OFF), Sequence Jump Type (IMM), Rate Divider (1), PM Data Mode (DEG), Stretch Factor (1), and AM Memory Mode (AM). The second column (PM) has: Sequence Mode (OFF), Dynamic Data Mode (SYNC), Memory Address Out (OFF), Sequence Jump Type (IMM), Rate Divider (1), PM Data Mode (DEG), Stretch Factor (1), and AM Memory Mode (AM). The third column (FM) has: Sequence Mode (OFF), Dynamic Data Mode (SYNC), Memory Address Out (OFF), Sequence Jump Type (IMM), Rate Divider (1), PM Data Mode (DEG), Stretch Factor (1), and AM Memory Mode (AM). The fourth column (FREQ) has: Sequence Mode (OFF), Dynamic Data Mode (SYNC), Memory Address Out (OFF), Sequence Jump Type (IMM), Rate Divider (1), PM Data Mode (DEG), Stretch Factor (1), and AM Memory Mode (AM). An 'OK' button is located to the right of the Stretch Factor controls.

Figure 3-7. SID Extended Control Panel

HP FASS has three modes of operation: RAM mode, dynamic data mode, and dynamic sequence mode.

The mode of operation is selected by the Sequence Mode command. The INT (internal) parameter selects RAM mode. The EXTADDR (external address) parameter selects dynamic data mode. The LOCAL, MASTER, SLAVE, INDIV, and OFF parameters provide various options related to dynamic sequence mode.

In RAM mode, waveform data is loaded into one or more of the four modulation memories. Once the data is loaded, the sequencers inside the MDS address the modulation memories that contain the desired data.

In dynamic data mode, the sequencer is bypassed. In this mode you load waveform data into at least one of the four modulation memories. Then, in real-time, you must use an external source to provide the waveform addresses via the DYNAMIC DATA/DYNAMIC SEQUENCE input ports on the rear panel of the MDS. Dynamic data mode can run in either synchronous or asynchronous mode, as selected by the Dynamic Data Mode command. Synchronous mode is used when the external data source and the MDS run at the same clock rate. Asynchronous mode allows you to input data from a source with a clock unrelated to the HP FASS system clock.

Dynamic sequence mode allows you to randomly execute sequences in real time. In this mode, the desired sequence number is input through the DYNAMIC DATA/DYNAMIC SEQUENCE input ports on the rear panel of the MDS. The sequence begins executing when a sequence jump command or an external sequence jump signal is activated. The jump timing is determined by the Sequence Jump Type command.

The following table shows the valid parameters for each command, depending on the mode of operation.

Table 3-1. Valid Parameters Depending on Sequence Mode

Command	Valid Parameters		
	RAM Mode	Dynamic Data Mode	Dynamic Sequence Mode
Sequence Mode	INT	EXTADDR	LOCAL, MASTER, SLAVE, INDIV, or OFF
Dynamic Data Mode		SYNC or ASYNC	
Sequence Jump Type			IMM or EOS
Memory Address Out	ON or OFF	OFF	ON or OFF if Sequence Mode = SLAVE or OFF; OFF if Sequence Mode = LOCAL or MASTER, or INDIV.

Active Memory

This command selects the memory that is being accessed and to which subsequent commands apply. Only one memory can be active at a time. It is not necessary to select the active memory before setting a command parameter. Whenever a parameter is set, the memory to which it applies automatically becomes the active memory.

The equivalent HP-IB command is :FASS:MEM (*FASS Subsystem*).

AM Memory Mode

The AMPM memory can be used for either AM data or PM data. This command sets the type of data for which the AMPM memory will be used.

The parameters for this command are as follows:

Parameter	Description
AM	AMPM memory is used for amplitude modulation data.
PM	AMPM memory is used for phase modulation data.

The equivalent HP-IB command is :FASS:MEM (*FASS Subsystem*).

Dynamic Data Mode

This command sets the dynamic data mode for each memory. The Sequence Mode command must be set to EXTADDR in order for this command to take effect.

The parameters for this command are as follows:

Parameter	Description
ASYN	Asynchronous mode. Allows you to input data from a source with a clock unrelated to the HP FASS system clock at speeds slower than 250 ns.
SYNC	Synchronous mode. Data is input from a source that runs at the same clock rate as the MDS.

The equivalent HP-IB command is :FASS:DDAT (*FASS Subsystem*).

Memory Address Out

This command enables/disables addresses that are currently being accessed to be output on the DYNAMIC DATA/DYNAMIC SEQUENCE port on the rear panel of the MDS. This mode can only be turned on if the Sequence Mode command is set to OFF, INT, or SLAVE. See Table 3-1.

The parameters for this command are as follows:

Parameter	Description
On	Turns waveform memory addresses on.
Off	Turns waveform memory addresses off.

PM Data Mode

This command sets the data format for PM memory and the AMPM memory when it is set to PM mode.

The parameters for this command are as follows:

Parameter	Description
DEG	Degrees
RAD	Radians
INT	Internal format

The equivalent HP-IB commands are :FASS:DEG and :FASS:RAD (*FASS Subsystem*).

Rate Divider

This command sets the address rate divider for each memory, which slows down the sequencer. The sequencer dwells at an address for the number of clock cycles specified by the address rate divider.

The allowable range is 1 to 65536 clock cycles.

The equivalent HP-IB command is :FASS:ARAT (*FASS Subsystem*).

Sequence Jump Type

This command selects the jump type for all sequences in sequencer memory. Jump type is the method by which the sequencer moves to the next sequence.

The parameters for this command are as follows:

Parameter	Description
IMM	Jump Immediate. The sequencer immediately jumps to the next sequence as soon as the jump signal is received.
EOS	Jump at End-of-Sequence. The sequencer finishes the sequence it is currently executing and then jumps to the next sequence when the jump signal is received.

The equivalent HP-IB command is :FASS:SEQ:JTYP
(*FASS Subsystem*).

Sequence Mode

This sets the sequencer memory mode of operation for each memory. See the introduction to the SID Extended Control Panel and Table 2-1 for additional information about sequencer memory modes of operation.

The parameters for this command are as follows:

Parameter	Description
INT	Configures the sequencer to run in internal mode. The sequence jump signal comes from the group source.
EXTADDR	Places the sequencer memory in dynamic data mode. The sequencer is bypassed, and memory addresses are input into the DYNAMIC DATA/DYNAMIC SEQUENCE port on the MDS.
MASTER	Places the sequencer memory in external mode and configures it to drive all the sequencer memories that are in slave mode.
SLAVE	Sequencers in this mode receive dynamic sequencer data from the sequencer that has been set to master mode.
INDIV	Sets the sequencer to external mode without being a master or a slave.
LOCAL	Places the sequencer in external mode. Sequence numbers are input through the data port corresponding to the active sequencer.
OFF	Disables the sequence jump capability and turns sequencer input off.

The equivalent HP-IB command is :FASS:SEQ:MODE (*FASS Subsystem*).

Stretch Factor

This command sets the stretch factor used when downloading data to the AMPM or PM memories. The stretch factor determines how many times each data point in memory is duplicated.

The allowable values for this command are 1, 2, and 4.

The equivalent HP-IB command is :FASS:SFAC (*FASS Subsystem*).

SID Event Markers

The SID Event Markers screen (figure 3-8) is accessed by selecting **Event Markers...** on the SID Control Panel.

Commands on this screen assign marker outputs to the Event Markers on the rear panel of the MDS, set the Event Marker delay and set the Equal Address marker address. Markers can be set for each of the four modulation memories.

When a command is selected, the memory to which it applies automatically becomes the active memory.

After you have entered the desired data, select **OK** to return to the SID Control Panel.

The screenshot shows the 'SID Event Markers' screen with four columns representing modulation memories: AMPM, PM, FM, and FREQ. The FREQ column is selected with a radio button. Each column has four rows of controls: Event Marker1, Event Marker2, Marker Delay, and Marker Address. Below the controls is an 'OK' button.

	AMPM	PM	FM	FREQ
Event Marker1	SEQSTRT	SEQSTRT	SEQSTRT	SEQSTRT
Event Marker2	ADDR_EQUAL	ADDR_EQUAL	ADDR_EQUAL	ADDR_EQUAL
Marker Delay	1	1	1	1
Marker Address	0	0	0	0

OK

Figure 3-8. SID Event Markers Screen

Event Marker 1

Each of the four modulation memories (AMPM, PM, FM, and FREQ) is controlled by a sequencer. Each sequencer has eight marker outputs. This command assigns one of the marker outputs to the EVENT MARKER 1 port on the MDS.

See "MDS Rear Panel Features" in Appendix B of the *Remote Operation Reference* for the electrical characteristics of these markers.

The parameters for this command are as follows:

Parameter	Description
ADDR_EQUAL	Equal Address marker
LOOPSTRT	Loop Packet Start marker
PACKIDST	Pulsed Packet ID marker
PACKID	Packet ID marker
PACKSTRT	Packet Start marker
SCANSTRT	Scan Start marker
SEQSTRT	Sequence Start marker

The equivalent HP-IB command is :FASS:ESEL (*FASS Subsystem*).

Event Marker 2

This command assigns one of the sequencer's eight marker outputs to the EVENT MARKER 2 port on the MDS.

See Event Marker 1, above, for a list of parameters.

The equivalent HP-IB command is :FASS:ESEL (*FASS Subsystem*).

Marker Address

This command sets the sequencer's Address Equal marker to a specified address. This command sets the marker to the specified address regardless of whether or not the Address Equal marker is assigned to an Event Marker port.

The parameters for this command are as follows:

Active Memory	Allowable Addresses
AMPM	0 to 262140 in multiples of 4
PM	0 to 262140 in multiples of 4
FM	0 to 65535
FREQ	0 to 65534 in multiples of 2

The equivalent HP-IB command is :FASS:MARK:ADDR (*FASS Subsystem*).

Marker Delay

This command sets the number of clock cycle delays on the marker output.

If the internal clock is used, one clock cycle delay is equal to 29.8 ns.

You can set the delay from 1 to 64 clock cycles.

Setting the delay to 1 is as close as Model 11 hardware can come to approximating the delay in Model 10 hardware.

The equivalent HP-IB command is :FASS:MDEL (*FASS Subsystem*).

This page is intentionally left blank.

Pull Down Menus

SID has seven pull down menus:

- File
- Edit
- Utilities
- Options
- WGL
- Window
- Help

Each of these menus have commands associated with them.

Note



If a command cannot be used in a particular situation, it is grayed out.

To access commands in a menu, click on the menu title using the left mouse button. A list of commands appears beneath the menu title. To close a menu, click anywhere outside the menu.

Menu commands cannot be accessed while a dialog box is open.

File Menu

The File menu (figure 3-9) provides commands that are useful for manipulating files.

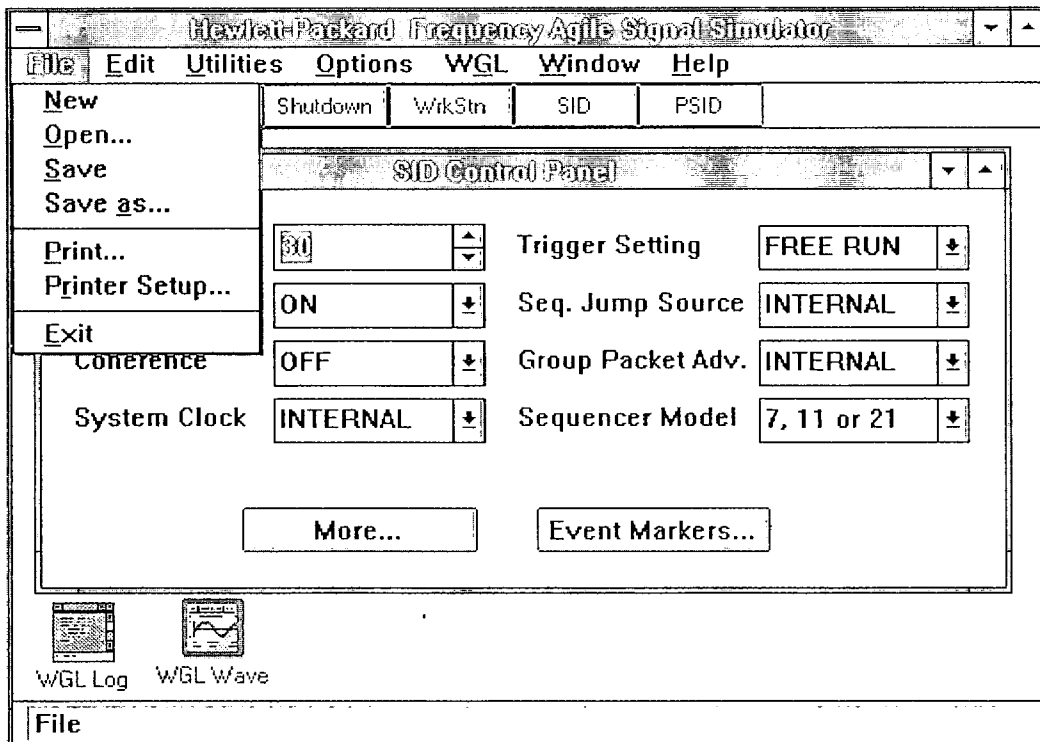

Figure 3-9. File Menu

The primary function of the first four commands (**New**, **Open**, **Save**, and **Save As**) is to manipulate ASCII text files, created with a built-in ASCII text editor. The **New** command allows you to create a new file, which can then be saved to either the removable cartridge (drive C:) or a 3.5 inch floppy disk (drive A:). The **Open** command allows you to open an existing file. Up to three files can be open at one time. An open file can be saved, using either the **Save** or the **Save As ...** command. The **Save**

command writes over the original file. The **Save As ...** command saves the file to another file name, while leaving the original file intact.

The next two commands, **Print ...** and **Printer Setup ...**, are for printing.

The **Printer Setup ...** command allows you to select the destination printer. The **Print ...** command allows you to print the contents of the active window to the destination printer for the WGL Working Wave, the ASCII text editor, and the WGL command log. For SID and the application IDs, the settings are printed, not the actual window contents.

Before printing from SID for the first time, you will need to install your printer in Microsoft Windows. See the beginning of this chapter for instructions on installing a printer.

New Opens an untitled window in the ASCII text editor for creating a new file. Commands for editing the file are found in the Edit menu. When you save the file, the title bar of the window changes to the name of the file.

To close this window (after saving the file, if you wish), double click on  (the control-menu box) in the upper left corner of the title bar.

Open ... Opens the File Open dialog box, which prompts you for the name of an existing file to load into the ASCII text editor. Commands for editing this file are found in the Edit menu.

When the file is opened, it appears in the ASCII text editor. The insertion bar is put at the end of the file.

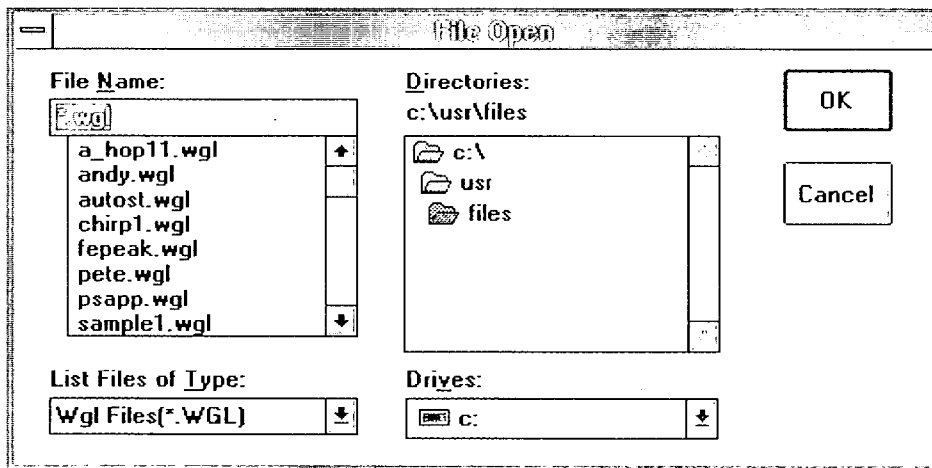

Figure 3-10. File Open Dialog Box

Save Saves changes to an existing file.

Save as ... Opens the File Save dialog box. Names and saves a new file or saves an existing file under a new name.

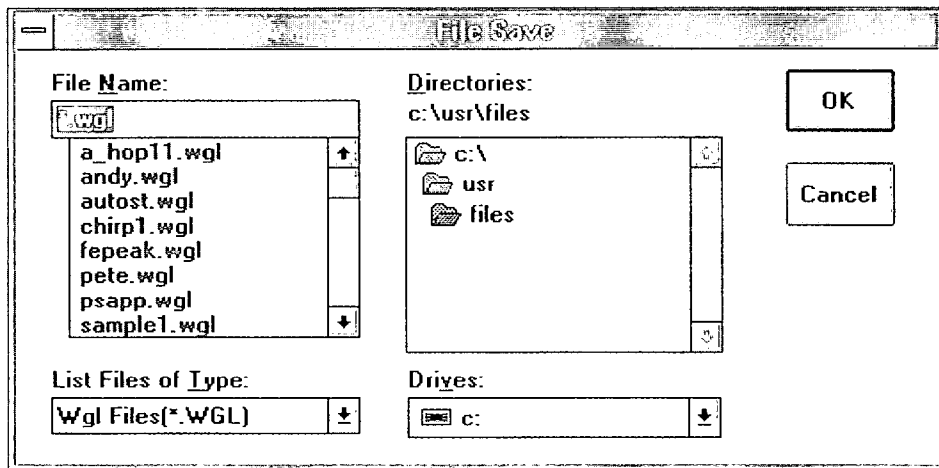

Figure 3-11. File Save Dialog Box

Print ... Opens the Print dialog box, which allows you to direct the entire contents of the active window to a printer. (The active window is the window whose title bar is highlighted.) The printer is installed using the Windows Control Panel.

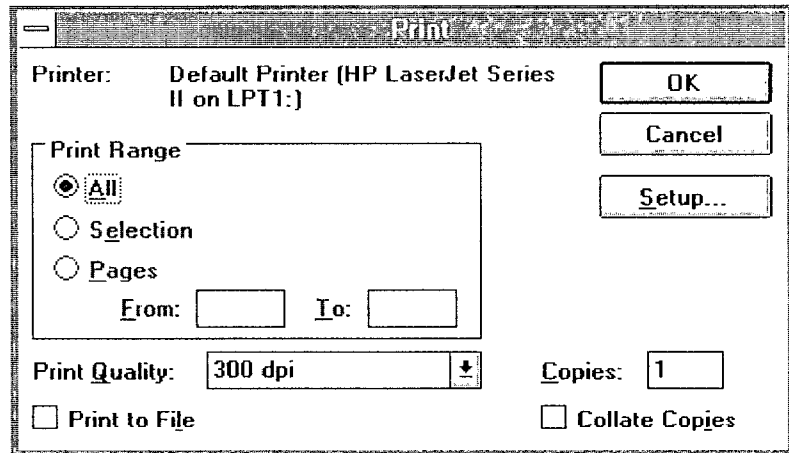

Figure 3-12. Print Dialog Box

Printer Setup ...

Opens the Print Setup dialog box. It allows you to select the destination printer to which SID will print. The destination printer must have previously been installed in Microsoft Windows (see the Print.. command).

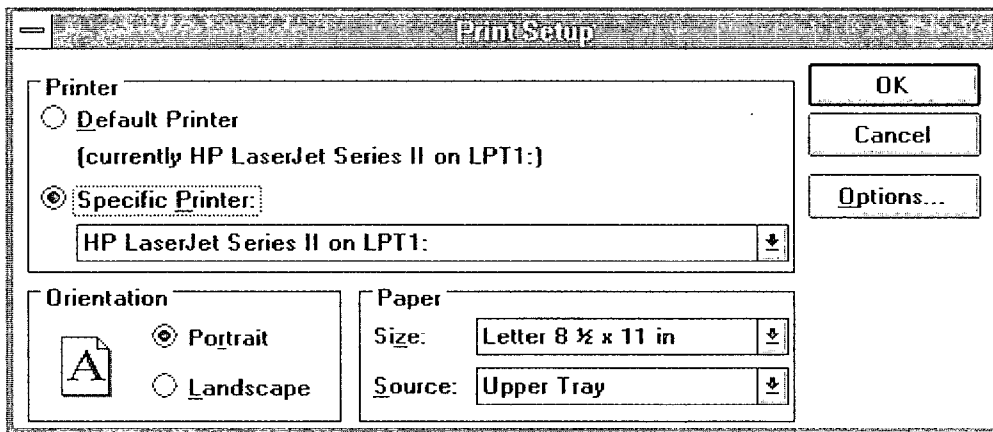

Figure 3-13. Print Setup Dialog Box

Exit This command closes SID and WGL and returns to Microsoft Windows.

Edit Menu

The Edit Menu (figure 3-14) allows you to edit files in the ASCII text editor. The commands in this menu can also be used to transfer data between the text editor and WGL. A temporary storage location, called the clipboard, is used to transfer the data.

A brief description of each command is presented in the following paragraphs. For a more complete explanation of editing WGL files, see the *HP Waveform Generation Language Programming Reference*.

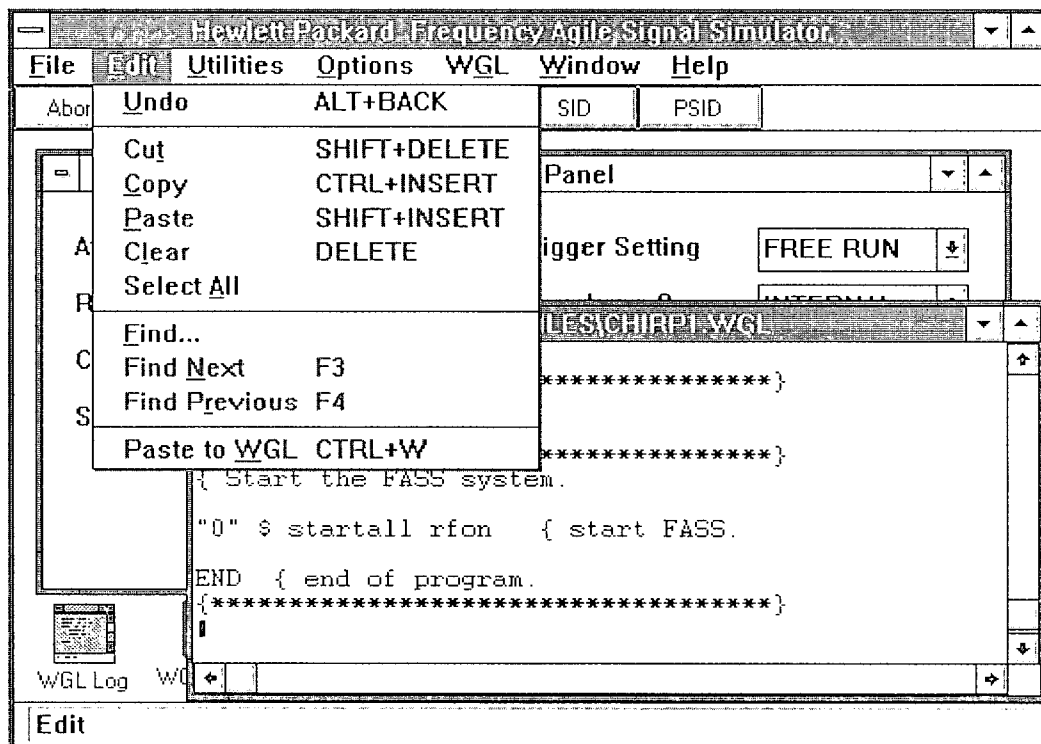

Figure 3-14. Edit Menu

- Undo** Reverses the most recently executed action in the text editor.
- Cut** Copies the highlighted selection to the clipboard and removes it from the file being edited.
- Copy** Makes a copy of the selected information, leaving the selected information in its original location.
- Paste** Inserts the information that was highlighted by the Copy command in a specified area. You cannot paste to the WGL Command Log.
- Clear** Removes highlighted information from an object without copying it to the clipboard. The space is compressed.
- Select All** Highlights the entire active editor window contents for selection by the Cut or Copy command.
- Find ...** Opens the Find dialog box. Enter the word or phrase you want to find in the Find text box. Then select **Next** or **Previous** to find the previous or next occurrence.

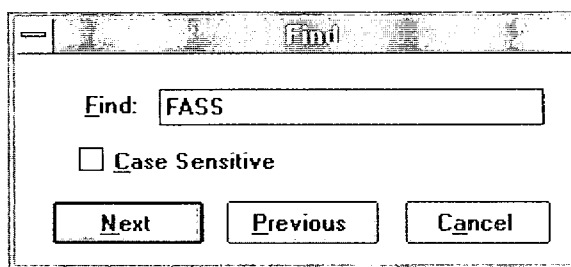

Figure 3-15. Find Dialog Box

- Find Next** Finds the next occurrence of the word or phrase last specified in the Find dialog box.
- Find Previous** Finds the previous occurrence of the word or phrase last specified in the Find dialog box.
- Paste to WGL** Loads and executes in WGL the contents of the clipboard. Definitions are compiled and commands not enclosed within definitions are executed immediately.

Utilities Menu

Commands in the Utilities menu (figure 3-16) allow you to control the HP FASS hardware.

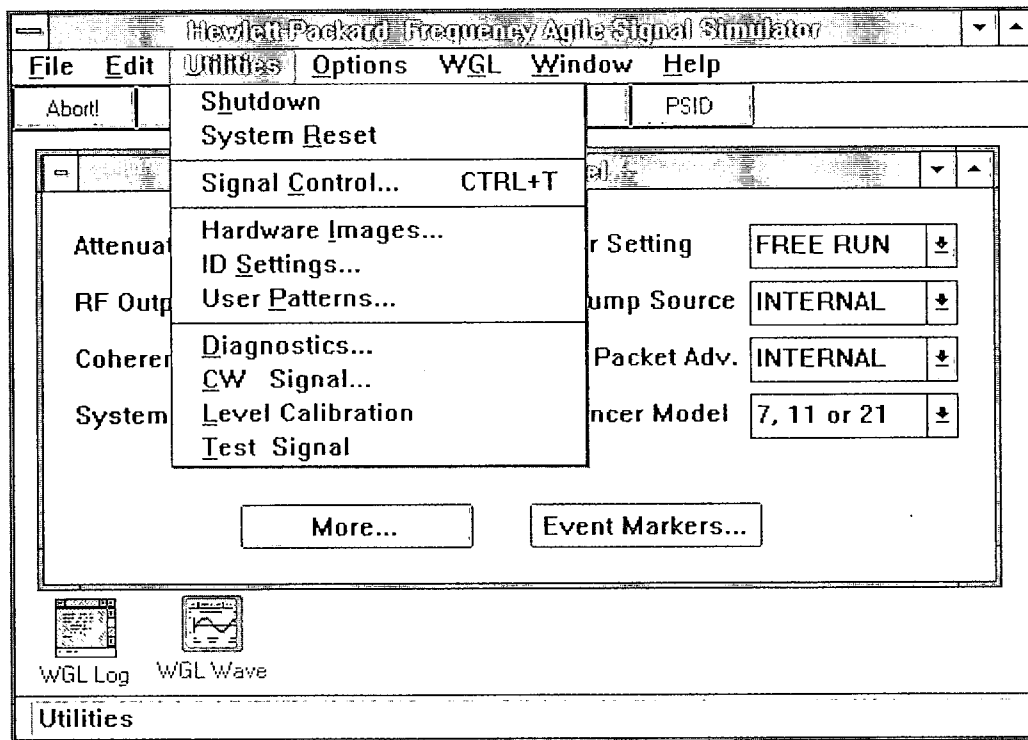

Figure 3-16. Utilities Menu

Using the Shutdown command prior to turning off the system ensures that the system will boot up with its current hardware and software settings (excluding Windows settings).

System Reset sets the system to default values.

Signal Control opens a dialog box that allows you to start, stop, and trigger the output signal.

The **Hardware Images**, **ID Settings**, and **User Patterns**, commands open dialog boxes that provide additional commands for managing your images, settings, and patterns.

The last four commands in the menu are used primarily for calibration and service.

Hardware images, ID settings, and user patterns allow you to save components of a signal you have created. A hardware image is an exact copy of the HP FASS instrument state. An ID setting is the application information, such as front panel button settings, of an ID. User patterns are ASCII text files that are used to customize application IDs.

Images, settings, and patterns can be saved on the removable cartridge or on a floppy disk. A floppy disk must be formatted for MS-DOS prior to being used for storing images, settings, or patterns. See the beginning of this chapter for instructions on formatting a disk.

After a floppy disk has been formatted for MS-DOS, it must be initialized for the type of data that will be stored (either images, settings, patterns). Initialization occurs the first time you try to copy to the floppy disk. A window pops up asking if you want to initialize the disk for the type of data you want to store. Select **OK** to initialize the disk.

If you try to load an image, setting, or pattern from a disk that has not been initialized an error occurs. An error also occurs if the disk contains the wrong type of data for the command you are using.

A floppy disk can contain a maximum of one hardware image, 12 ID settings, or 20 user patterns.

Shutdown Stores all of the hardware and application information, excluding Windows settings, that currently resides in the HP FASS system to the removable cartridge. When the system is restarted, it returns to the system configuration that was active at shutdown. The hardware and application information is restored.

This command stores the hardware information in hardware image 0 and the application information in ID setting 0. If these images and settings are removed, errors may occur on boot up.

Reset the system prior to using **Shutdown** if you do not want to store your current settings on the removable cartridge.

When you select the **Shutdown** command, a warning message is displayed. If you select **Yes** to proceed with shutdown, the Shutdown Application window appears when the system shutdown is complete.

The equivalent HP-IB command is :SID:SHUT (*SID Subsystem*).

System Reset This command resets the system hardware to default conditions.

Table 3-2 provides a list of the SID defaults conditions. See table 2-1 in chapter 2 for a list of the PSID default conditions.

The equivalent HP-IB command is *RST (*Common Commands*).

Table 3-2. SID Default Values

Parameter	Default Value
SID Control Panel	
Attenuator	30 dB
RF Output	On
Coherence	Off
System Clock	Internal
Trigger Setting	Free run
Sequence Jump Source	Internal
Group Packet Advance	Internal
Sequencer Model	7, 11, or 21
SID Extended Control Panel	
Active Memory	Frequency
Sequence Mode	Internal
Dynamic Data Mode	Synchronous
Memory Address Out	Off
Sequence Jump Type	Immediate
Rate Divider	1
PM Data Mode	Degrees
Stretch Factor	1
AM Memory Mode	AM

Table 3-2. SID Default Values (continued)

Parameter	Default Value
SID Event Markers	
Event Marker 1	Sequence Start
Event Marker 2	Equal Address
Marker Delay	1
Marker Address	0
Utilities Menu Commands	
CW Signal Frequency	33.554432 MHz
CW Signal Level	0.00 dBm
Options Menu Commands	
HP-IB Address	19 (or last address entered prior to system shutdown)
Special Function 14.1 (AUC Output Attenuator)	30 dB (Model 11) 10 dB (Model 21)
Special Function 14.3 (AMUC Low Output Attenuator)	30 dB
Special Function 14.4 (AMUC High Output Attenuator)	30 dB
Special Function 14.5 (AMUC Input Attenuator)	0 dB

Signal Control.. Opens the Signal Control dialog box (figure 3-17)

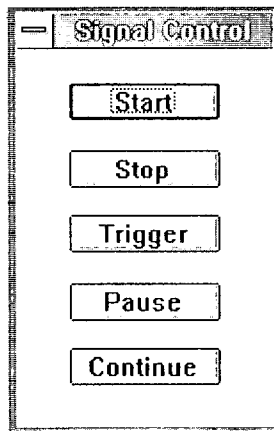

Figure 3-17. Signal Control Dialog Box

Commands in the Signal Control dialog box control the output signal. Which commands are valid to control the output depends on the trigger setting, which is set on the SID Control Panel.

Command	Valid Trigger Settings
Start	Free Run
Stop	Free Run
Trigger	External Continuous External Single
Pause	External Continuous External Single
Continue	External Continuous External Single

The equivalent HP-IB commands are as follows:

- :FASS:STAR (*FASS Subsystem*)
 - :FASS:STOP (*FASS Subsystem*)
 - :TRIG:IMM (*Trigger Subsystem*)
 - :TRIG:PAUS (*Trigger Subsystem*)
 - :TRIG:IMM (*Trigger Subsystem*)

The following commands are available in the Signal Control dialog box:

Start

Starts the signal from the beginning of the sequence.

Stop

Stops the system.

Trigger

Triggers the system to start running.

If the Trigger Setting is External Single, only triggers the sequence once because the sequence automatically stops after completing the sequence.

Pause

When a signal is being generated, this command causes the system to pause at the current frequency and amplitude.

Continue

Continues generating a signal, starting at the point where it was paused.

Hardware Images ... The Hardware Images command opens the Hardware Images dialog box (figure 3-18).

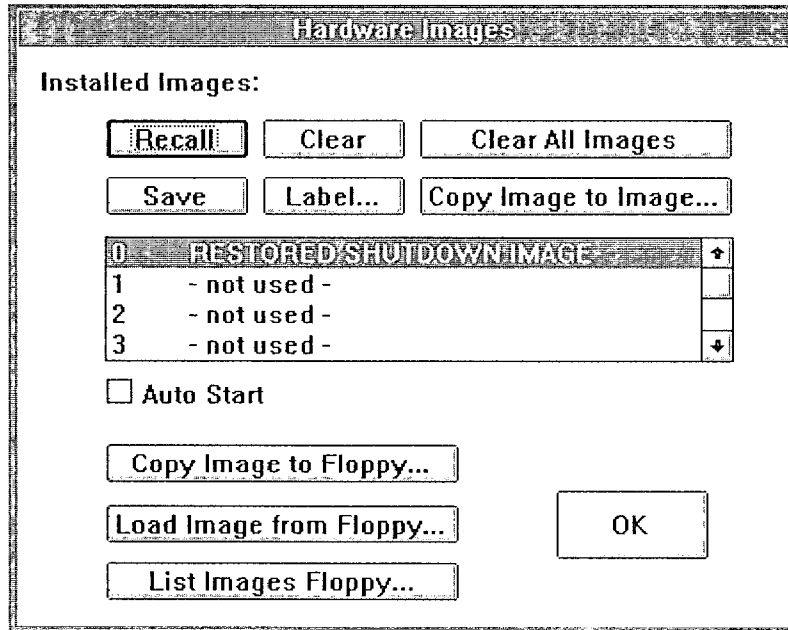

Figure 3-18. Hardware Images Dialog Box

A hardware image consists of the hardware memory and hardware settings that are necessary to recreate a signal.

HP FASS has six registers available for storing hardware images. All of these registers are located on the removable cartridge. Image register 0 is used to store the current hardware state with the **Shutdown** command.

Image registers 1 through 5 should be used for more permanent storage. Use the hardware image **Save** command to save images and the hardware image **Recall** command to recall images. One hardware image can be installed on a 3.5 inch, high density 1.44 MByte floppy disk. (This is a compressed file and takes a while.)

When a hardware image is recalled, it replaces the existing hardware configuration with that of the image. Recalling a hardware image does not change the current ID settings, and these settings are probably different than the signal defined by the hardware image.

If the Trigger Setting is set to Free Run, use the **Start** command to generate the signal defined by the hardware image.

If the Trigger Setting is set to External Continuous or External Single, use the **Trigger** command to generate the signal defined by the hardware image.

The following commands are available in the dialog box.

Recall

Recalls a hardware image that was previously saved. Highlight the image you want to recall and then select **Recall**.

To generate a signal (if the trigger setting is free run), select Auto Start and then recall an image. A signal can also be generated by recalling an image and using **Start** in the Signal Control box.

The equivalent HP-IB command is :SID:IMAG:REC
(*SID Subsystem*).

Save

Saves the current hardware image to the specified hardware image number on the removable cartridge. Highlight the image register where you want to save the current hardware image and then select **Save**.

The equivalent HP-IB command is :SID:IMAG:SAVE
(*SID Subsystem*).

Clear

Clears specified hardware image on the removable cartridge. Highlight the image register you want to clear and then select **Clear**.

Label

Labels the selected hardware image on the removable cartridge.

Clear All Images

Clears all hardware images on the removable cartridge, except register 0.

Copy Image to Image ...

Opens the Duplicate Hardware Image dialog box. The dialog box allows you to copy a specified hardware image to one of the other hardware images on the removable cartridge.

The equivalent HP-IB command is :SID:IMAG:DUP (*SID Subsystem*).

Auto Start

Automatically generates a signal once an image is recalled. Click on this box to select/deselect the Auto Start option. If Auto Start is selected, highlight a register and select **Recall**. The signal will be generated if the Trigger Setting is free run. If the Trigger Setting is external single or external continuous, the signal will be generated when the system is triggered.

Copy Image to Floppy ...

Opens the Copy Hardware Image dialog box. The dialog box allows you to specify a hardware image on the removable cartridge to be copied to the floppy disk.

Note

Copying a complete hardware image could require as much as 2.8 MBytes of memory, depending on the image, but will typically require in the range of 600 KBytes. Compression of data enables the images to fit on a floppy disk. The actual size depends upon the amount of data compression that can be achieved for the given image. Some hardware images may not compress enough to fit on a floppy disk and MS-DOS error number 000834 will be displayed. When this occurs, select **OK** for this error message and system error 913 that follows. No data is saved on the floppy disk.

Load Image from Floppy ...

Opens the Load Hardware Image dialog box. The dialog box allows you to specify an image on the floppy to be loaded onto the removable cartridge.

The equivalent HP-IB command is :SID:IMAG:LOAD (*SID Subsystem*).

To load a hardware register from disk:

1. Insert a floppy disk that contains a hardware image into drive A.
2. Select **Hardware Images ...** from the Utilities menu.
3. When the Hardware Images dialog box appears, select **Load Image From Floppy...**.
4. When the Load Hardware Image dialog box appears, enter the name of the image in the "From Floppy:" box. Open the list box and highlight the register to load the image into in the "To Removable Cartridge" box and select **OK**.

If Shutdown is selected prior to turning off power, the current hardware image is stored in image register 0 on the removable cartridge. If another hardware image is already stored in image register 0, it will be overwritten.

If a hardware image is loaded over HP-IB, the shutdown information in image register 0 is overwritten.

List Images Floppy . . .

Opens the List Floppy Disk dialog box. The dialog box lists the contents of the floppy disk in a list box.

ID Settings . . .

The ID Settings command opens the Application State Settings dialog box shown in figure 3-19.

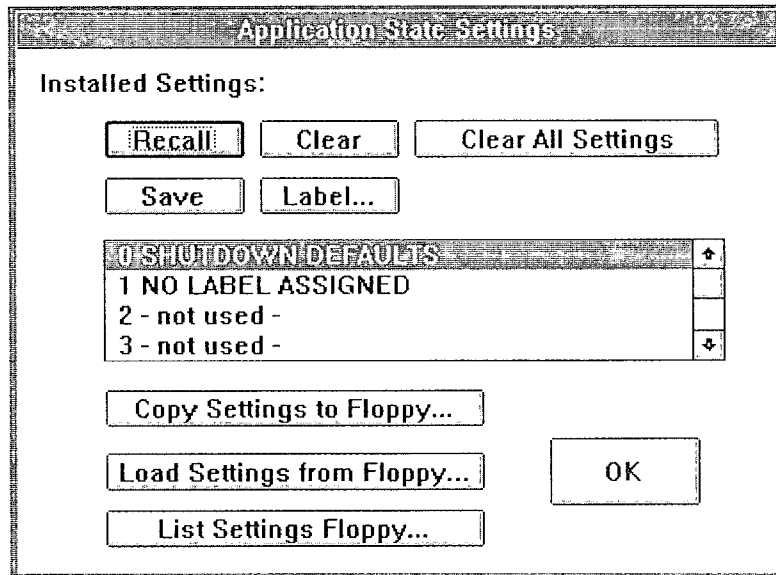

Figure 3-19. Application State Settings Dialog Box

ID settings are application data, such as front-panel settings.

SID has 12 registers available for storing ID settings. These registers are located on the removable cartridge. In addition, a register 0 is used to store the ID settings when the Shutdown command is used.

Up to 12 ID settings can be saved on a 3.5 inch, dual capacity 1.44 MByte floppy disk.

When an ID setting is recalled, it replaces the current application settings with those contained in the recalled ID setting register. Most ID settings are only used with application IDs (for example, PSID). However, it is possible to save settings with SID only (for example, the clock source).

The following commands are available in the dialog box.

Recall

Recalls any ID setting that was previously saved. Highlight the setting you wish to recall, then select **Recall**.

The equivalent HP-IB command is :SID:SET:REC (*SID Subsystem*).

Save

Saves the current ID settings data to the specified ID setting number on the removable cartridge. Highlight the register where you want the settings saved and then select **Save**.

The equivalent HP-IB command is :SID:SET:SAVE (*SID Subsystem*).

Clear

Clears the selected ID setting on the removable cartridge except 0.

Label . . .

Labels the selected ID setting on the removable cartridge.

Clear All Settings

Clears all ID settings on the removable cartridge.

Copy Settings to Floppy ...

Opens the Copy Application State Settings dialog box. You can copy one or more settings from the removable cartridge to floppy disk. **Copy All Settings to Floppy** copies all ID settings to the floppy disk from the removable cartridge.

Load Settings From Floppy ...

Opens the Load Application State Settings dialog box. Loads the specified ID setting from the floppy disk to the removable cartridge. **Load All Settings from Floppy** loads all ID settings from the floppy disk to the removable cartridge.

To load an ID setting from a floppy disk:

1. Select **ID Settings** from the Utilities menu.
2. When the Application State Settings dialog box appears, select **Load Settings From Floppy** and **OK**.
3. In the Load Application State Settings dialog box, select the ID setting you want to load and select **OK**.

List Settings Floppy ...

Lists the contents of the floppy disk.

User Patterns ... Opens the following User Patterns dialog box (figure 3-20)

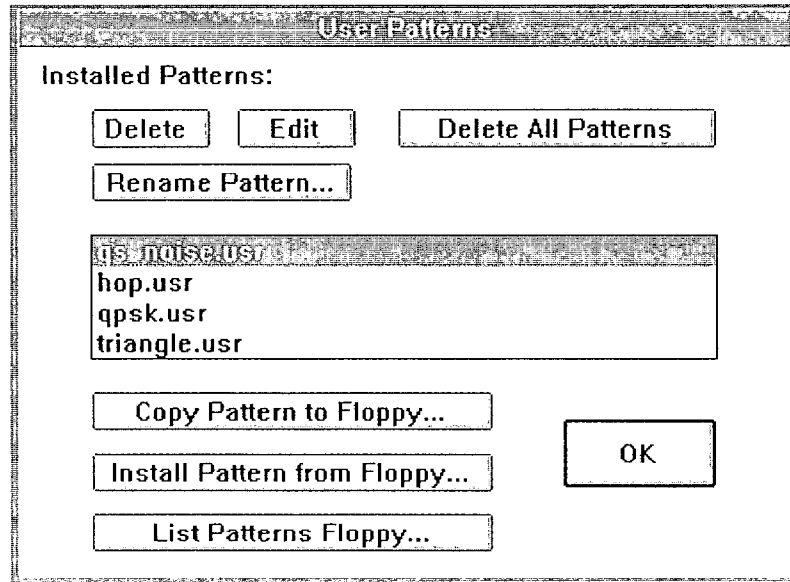

Figure 3-20. User Patterns Dialog Box

User patterns are ASCII text files that are used by IDs to customize an application. The first number in the file indicates the number of data points in the pattern. This is followed by the actual data points. Scaling and usage of the user pattern are defined by the application ID. The user pattern must be installed on the removable cartridge before it can be used by a command.

Because user patterns are ASCII files, they can be created by any application that can write an ASCII file. An ASCII text editor is included as part of SID. However, you can also generate user patterns using a spreadsheet application or a general purpose language such as BASIC.

A user pattern name consists of a filename with a **.USR** extension. The filename can be up to eight characters in length.

The following commands are available in the dialog box.

Delete

Deletes the highlighted user pattern from the removable cartridge.

Edit ...

Activates the ASCII text with the highlighted pattern in the editor window. There is a 60K character limit in the editor.

Rename Pattern ...

Allows you to rename the highlighted user pattern.
Opens the Rename dialog box to enter the new name.

Delete All Patterns ...

Deletes all user patterns from the removable cartridge.

Copy Pattern to Floppy ...

Allows you to copy the highlighted user pattern from the removable cartridge to a floppy disk installed in A: drive.

Install Pattern from Floppy ...

Copies a user pattern from the A:\PATTERNS directory on the floppy disk to the removable cartridge.

List Patterns Floppy ...

Lists the contents of the A:\PATTERNS directory on the floppy disk.

Diagnostics ... This command opens the System Diagnostics dialog box (figure 3-21).

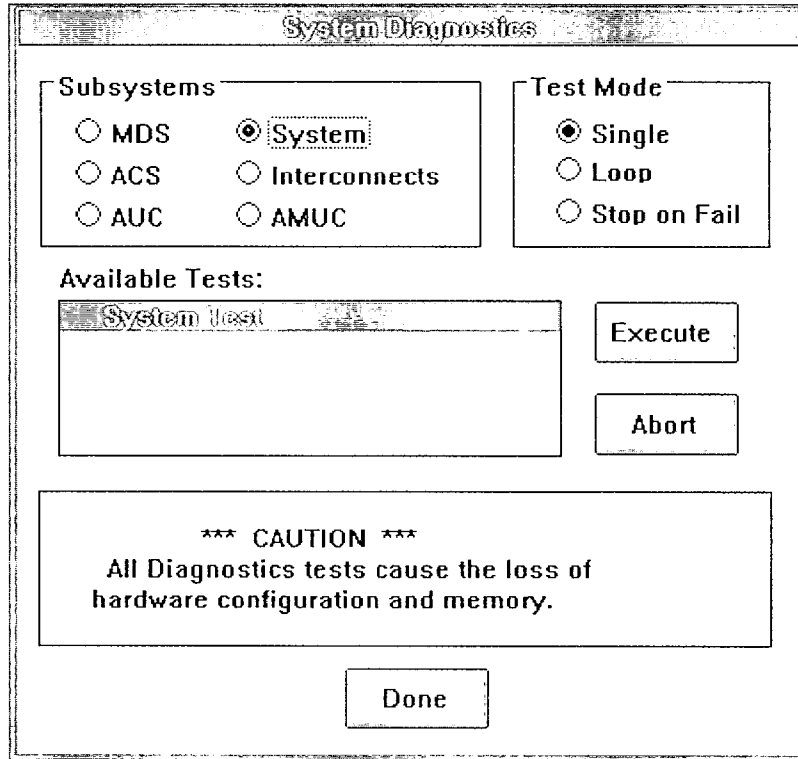

Figure 3-21. System Diagnostics Dialog Box

Refer to the *HP 8791 FASS System Service Manual* for additional information about running the diagnostics.

The equivalent HP-IB commands are :DIAG:TEST? and :DIAG:TRES? (*Diagnostic Subsystem*).

CW Signal ...

This command generates a continuous wave signal at the specified frequency and amplitude.

The default frequency is 33.554432 MHz and the level is 0 dBm.

The allowable parameters for this command are the following:

Parameter	Range
CW frequency	Model 7: 0 Hz to 50 MHz Model 11: 2 MHz to 3 GHz Model 21: 10 MHz to 19 GHz Resolution is 0.125 Hz. Enter value in hertz.
Amplitude	Model 7: -100 to +10 dBm Model 11: -107 to 22 dBm Model 21: -100 to +10 dBm Resolution is 0.1 dB.

Note



Be sure to enter frequency in hertz.

For Model 21, you can get a level of +10 dBm by using special function 14.1 to change the AUC output attenuator to 0 dB (default is 10 dB). However, the CW amplitude specifications may be degraded. The application output level specified will be 10 dB lower than the actual output level.

The equivalent HP-IB command is :DIAG: CW (*Diagnostic Subsystem*).

Level Calibration

Generates an internal level accuracy table for self-calibration. The table is used to level the output power across the output frequency range.

With Model 11 hardware, level correction is done in software. The level calibration procedure creates a set of cal factors that can be used in the AM memory to adjust the output level. The CW function in SID automatically uses these cal factors to generate signals at the correct level. In most cases, IDs such as PSID and RSID will also use the cal factors automatically.

With Model 21 hardware, the calibration procedure sets up the hardware so it will automatically compensate for differences in output level over the system's frequency range. Because the compensation is built into the hardware, it is not necessary for the software to perform any level adjustments. This means that Model 21 level calibration will correct the level in any mode (SID CW, RSID, PSID or WGL).

Model 7 hardware does not require a level calibration.

It takes approximately six minutes to perform the calibration on Model 11 hardware and approximately 20 minutes on Model 21 hardware. Calibration can be aborted at any time by selecting the **Abort!** command on the toggle ribbon.

The equivalent HP-IB command is :FASS:CAL (*FASS Subsystem*).

Test Signal

Causes the system to output a test signal that tests most of the system hardware capabilities. The test signal can be used to verify system operation.

The equivalent HP-IB command is :DIAG:SIGN (*Diagnostic Subsystem*).

Note



The test signal is shown using a spectrum analyzer. The overall test signal is shown first (figure 3-22 through 3-25). Then, for Models 11 and 21 only, four areas of interest are shown individually in figures 3-26 through 3-29.

For Model 21, figure 3-26, AM Test Signal, is displayed with the spectrum analyzer connected to the RF Output 0.05-0.5 GHz connector (Low Band). Figures 3-27 through 3-29 are displayed with the spectrum analyzer connected to the RF OUTPUT 0.5-1.8 GHz connector (High Band).

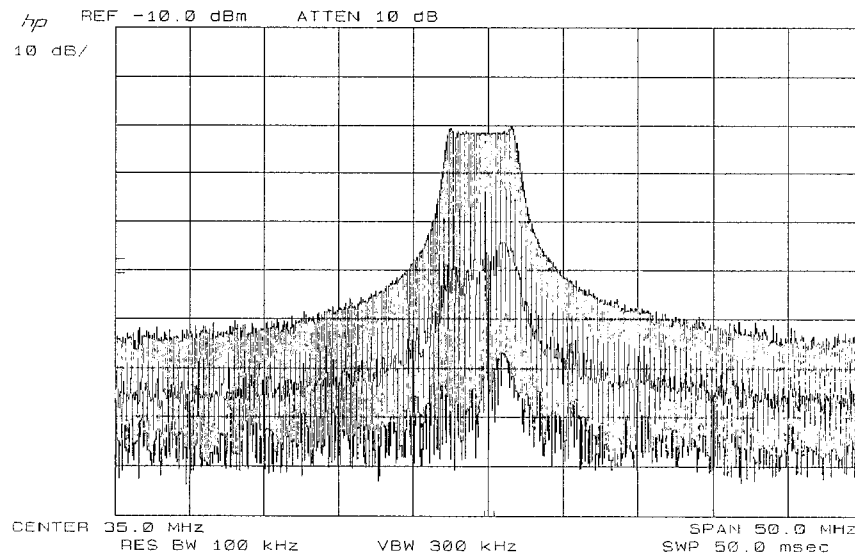

Figure 3-22. Model 7 Overall Test Signal

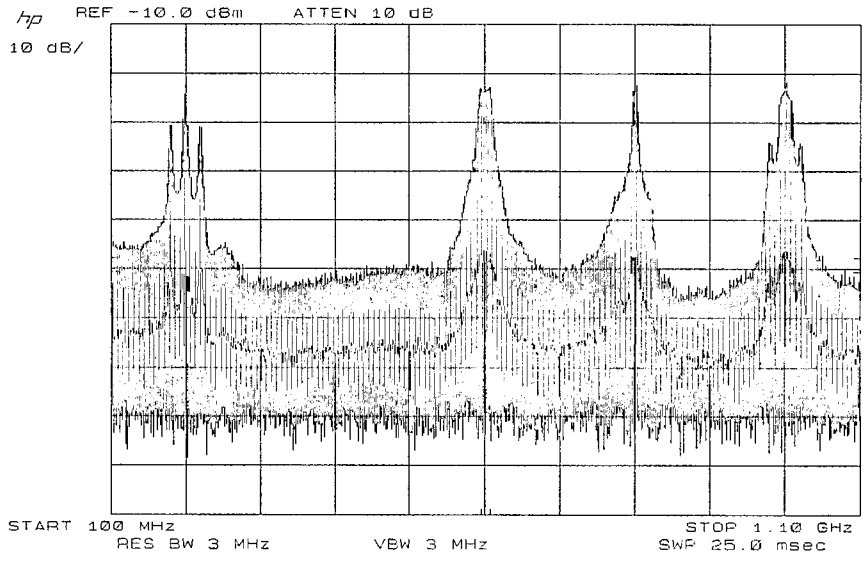

Figure 3-23. Model 11 Overall Test Signal

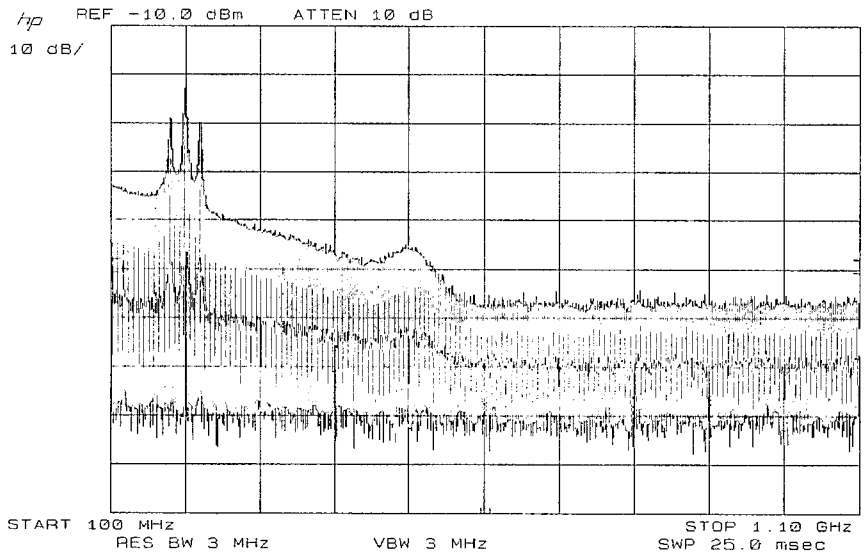

Figure 3-24. Model 21 Low Band Overall Test Signal

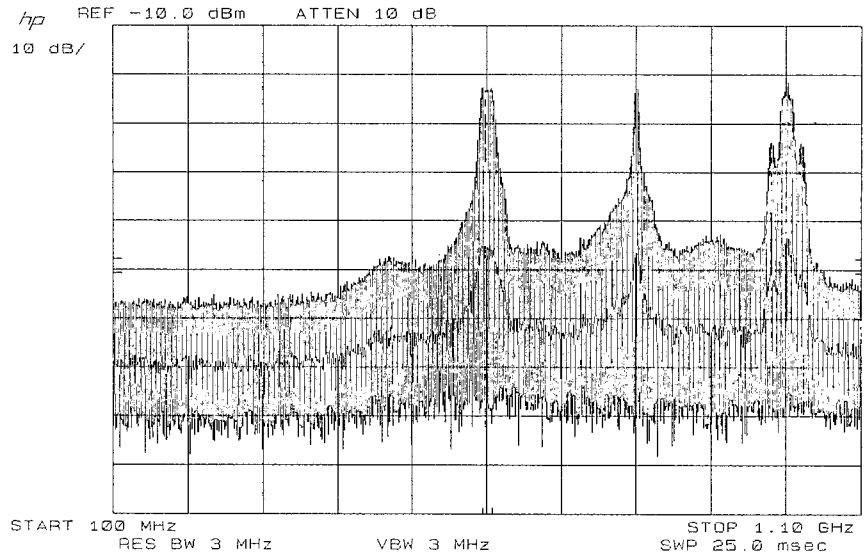

Figure 3-25. Model 21 High Band Overall Test Signal

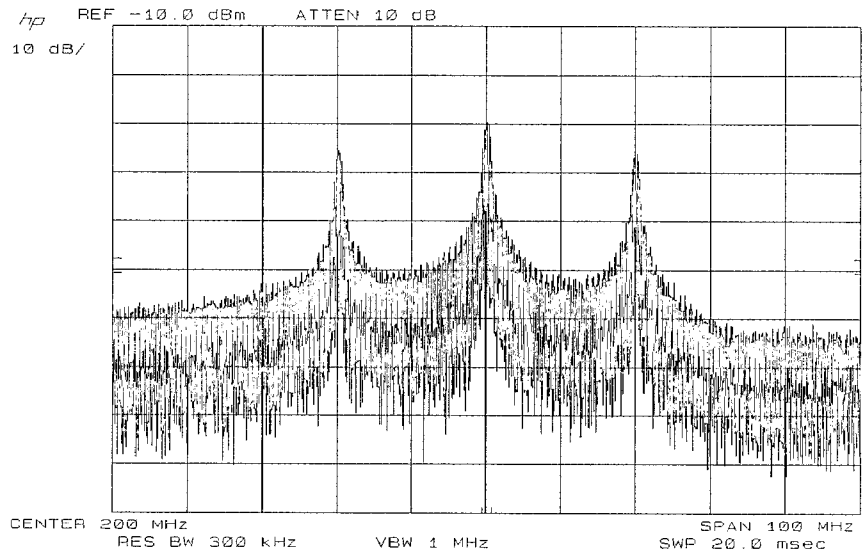

Figure 3-26. AM Test Signal (Models 11 and 21)

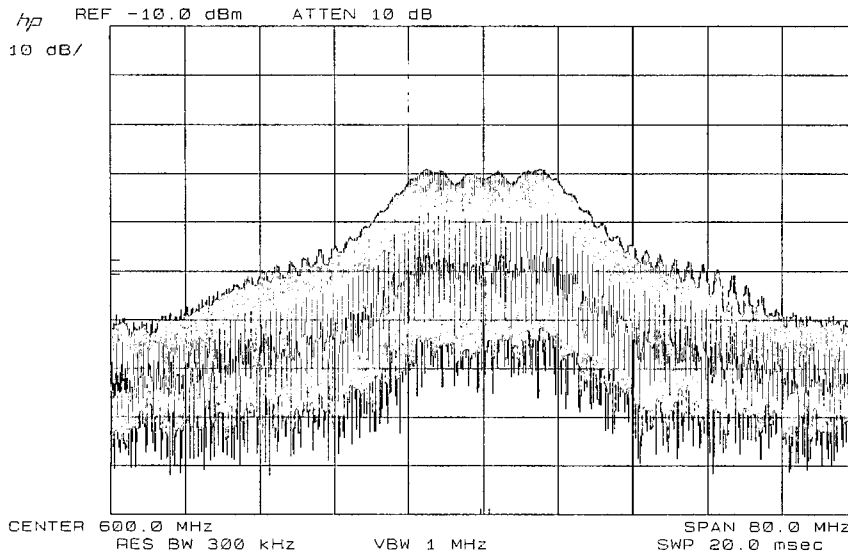

Figure 3-27. Linear Chirp Test Signal (Models 11 and 21)

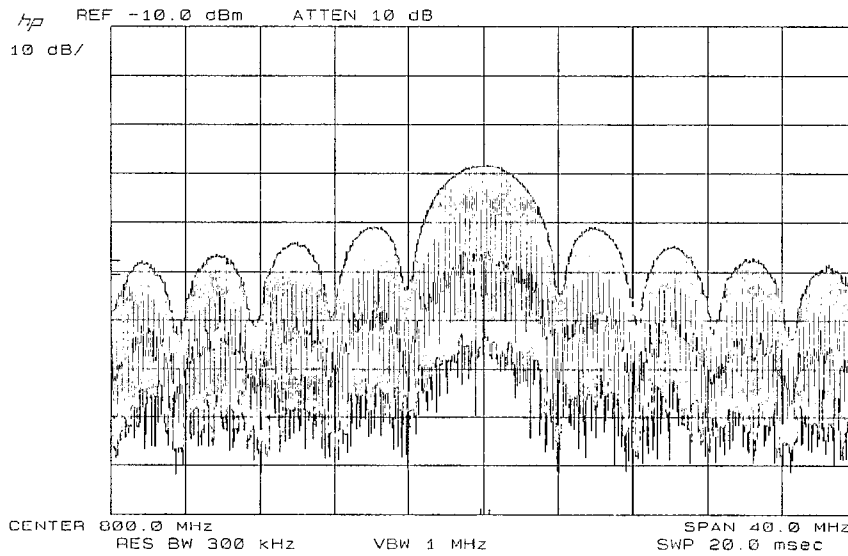

Figure 3-28. Pulse Carrier Test Signal (Models 11 and 21)

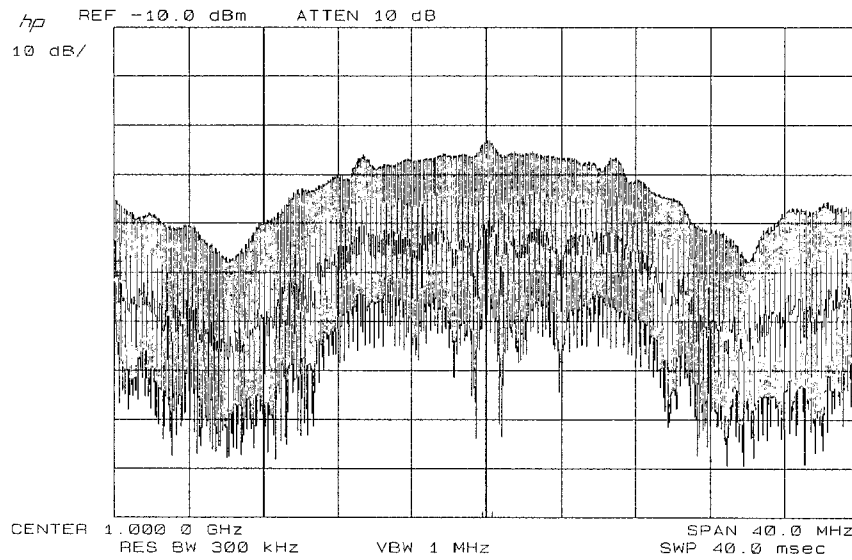

Figure 3-29. Thirteen Element Barker Code Test Signal (Models 11 and 21)

Options Menu

The Options menu (figure 3-30) provides commands to set the HP-IB address, access special functions, and control the color and font of the WGL Working Wave window.

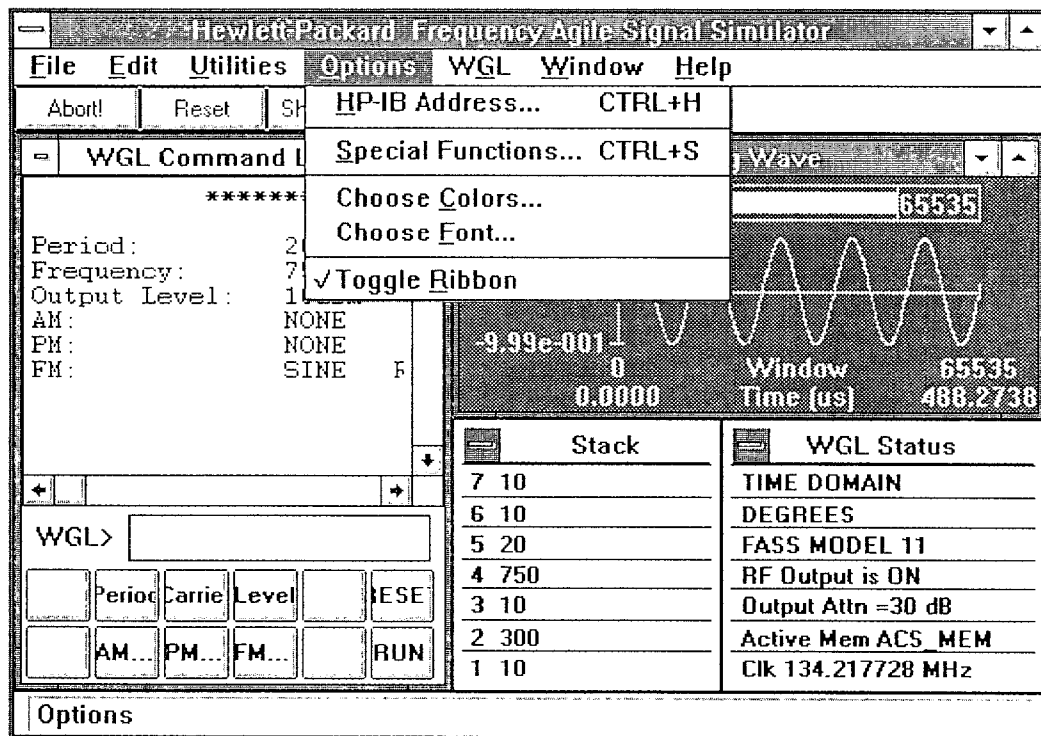

Figure 3-30. Options Menu

HP-IB Address ...

Opens the HP-IB Address dialog box, which prompts you for the system HP-IB address. Enter an address between 0 and 30 and then press **Enter** on the keyboard.

The system's HP-IB address is set to 19 when it is shipped from the factory.

The reset value of the HP-IB addresses is the last addresses it was set to prior to performing Shutdown.

Special Functions ...

Opens the Special Functions dialog box, shown in figure 3-31.

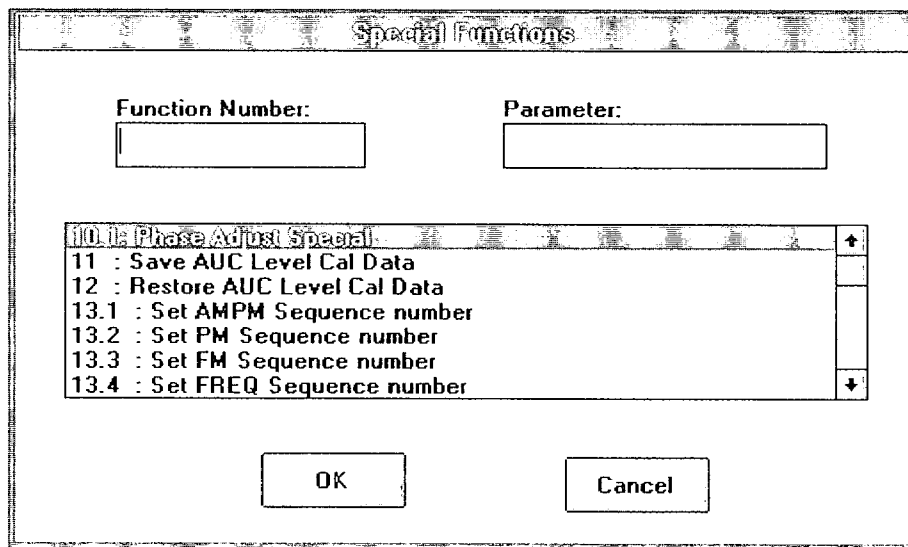

Figure 3-31. Special Functions Dialog Box

Note

Special functions perform certain functions with HP FASS that are not normally accessible from an application. To use special functions effectively requires more system and application knowledge than most other operations. If you need to use these functions and do not understand all of the possible side effects, contact your HP representative.

To implement a special function:

1. Select the special function you want to implement, either by highlighting the special function or entering the number in the Function Number text box.
2. If a special function has an additional parameter, enter it in the Parameter text box. Only special functions with fractional components have special parameters (for example 10.1 has additional parameters).
3. Press **Enter** on the keyboard. The special function is executed immediately.

See Table 3-3 for a list of special functions and their parameters.

Table 3-3. Special Functions

Special Function Number	Parameters	Description
10.1	-180° to +180°	Phase Adjust - adjusts the phase of the carrier frequency by loading a constant offset to PM memory. This is used to align the phase of two HP FASS systems. This special function disables phase modulation and overwrites the contents of PM memory.
11	0	Save AUC Level Cal Data - applies to Model 21 only. Can be used to save level calibration data prior to turning off power.
12	0	Restore AUC Level Cal Data - applies to Model 21 only. Restores the level calibration data that was saved using special function 11.
13.1	-1 to 1023	Set AMPM Sequence Number - selects the sequence in AMPM memory to be executed at the next sequence jump. The sequence mode is set to internal.
13.2	-1 to 1023	Set PM Sequence Number - selects the sequence in PM memory to be executed at the next sequence jump. The sequence mode is set to internal.
13.3	-1 to 1023	Set FM Sequence Number - selects the sequence in FM memory to be executed at the next sequence jump. The sequence mode is set to internal.
13.4	-1 to 1023	Set FREQ Sequence Number - selects the sequence in Frequency memory to be executed at the next sequence jump. The sequence mode is set to internal.
14.1	0 to 70 dB in 10 dB steps	Set AUC Output Attenuator - allows individual control of the AUC output attenuator for Model 21. Normally, the AUC output attenuator is set to 10 dB fixed for Model 21. For Model 11, the attenuator commands control the AUC output attenuator and this special function is not needed. Specifications will be downgraded when this special function is used.

Table 3-3. Special Functions (continued)

Special Function Number	Parameters	Description
14.2	0 1	<p>Set AUC Mode - determines how AUC translates the upconversion frequency band data. HP FASS automatically sets the AUC model based on whether or not an AMUC is present. This special function allows you to change the automatic setting.</p> <p>Model 11 Model 21</p>
14.3	0 to 110 dB in 10 dB steps	<p>Set AMUC Low Output Attenuator - allows individual control of the AMUC output attenuator for the 50 MHz to 500 MHz output.</p>
14.4	0 to 110 dB in 10 dB steps	<p>Set AMUC High Output Attenuator - allows individual control of the AMUC output attenuator for the 500 MHz to 18 GHz output.</p>
14.5	0 to 11 dB in 1 dB steps	<p>Set AMUC Input Attenuator - allows individual control of the input attenuator to the AMUC.</p>
15	0	<p>Broadband Upconverter Menu - displays a menu on the front panel if a Broadband Microwave Upconverter is connected to the private bus.</p>
16	0	<p>Display Upconverter Settings - displays the LO and Broadband Microwave Upconverter settings on the front panel.</p>
16.1	1 to 12	<p>Set Upconverter Band - sets E2500A (options K01, K02, K09) Broadband Microwave Upconverter (BMUC) band settings. Sets BMUC band independent of LO settings.</p>

Table 3-3. Special Functions (continued)

Special Function Number	Parameters	Description
16.2	1 to 12	Set Upconverter Band and LO - sets E2500A (options K01, K02, K09) Broadband Microwave Upconverter (BMUC) band and LO settings. Sets BMUC band, LO frequency, and LO output level.
16.3	0 to 110 in steps of 10	Set Upconverter Attenuator - sets the E2500A (options K01, K02, K09) Broadband Microwave Upconverter output attenuation from 0 to 110 dB in 10 dB steps (default = 0 dB).
16.4	Frequency in Hz	Set LO Frequency - sets the E2500A (options K01, K02, K09) Upconverter LO frequency in Hz.
16.5	Level in dBm from +12 to -20 dBm	Set LO Level - sets the E2500A (options K01, K02, K09) Upconverter LO level in dBm from +12 to -20 dBm.
17	0	Display Upconverter Band Info - displays the E2500A (options K01, K02, K09) Broadband Upconverter band information on the front panel.
20	0	Change to alternate hardware image directory - switches to the alternate hardware image directory on the removable cartridge. This increases the amount of hardware images that can be stored. In order to access the alternate hardware image directory, all image registers in the main directory must contain images.
21	0	Change to main hardware image directory - switches from alternate hardware image directory to the main hardware image directory.
39	0	Instrument Firmware Version - displays the firmware version of the ACS, AUC, AMUC, and MDS on the front panel.
40	0	Set Cal Factors to 1 - sets all the calibration factors to 1. See the CAL command in the FASS subsystem for additional information about calibration. Applicable only to Model 11.
40.1	>0 and <1	Set Cal Factors - sets all calibration factors to a specified value. Applicable only to Model 11.

Table 3-3. Special Functions (continued)

Special Function Number	Parameters	Description
41.1	0 to 30	Set HP-IB Address - sets the HP-IB address over the HP-IB. This special function is intended for use with systems that do not have a keyboard, monitor, and mouse.
53.1		Best Signal to Noise - applies to HP FASS Model 11 and 21 only. This special function tries to improve the signal-to-noise ratio. The trade offs are that the distortion on AM will be worse and for HP FASS Model 11 the harmonics on the RF output will be worse.
	0	Disable best signal-to-noise ratio (default).
	1	Enable best signal-to-noise ratio.

Choose Colors ...

This command is available when the WGL Working Wave is the active window. Opens the Graph Color Elements dialog box (figure 3-32), which allows you to change the colors of elements in the WGL Working Wave window.

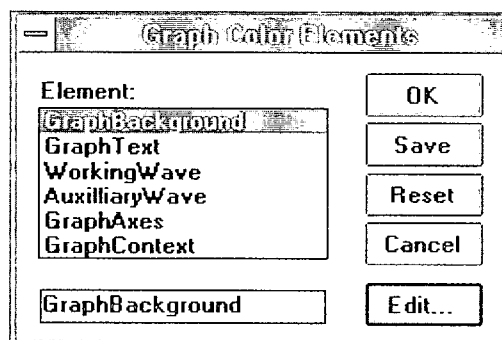

Figure 3-32. Graph Color Elements Dialog Box

To change colors:

1. Select the element whose color you want to change.
2. Select **Edit...**. The Colors dialog box opens.
3. Select a color and **OK** to close the Colors dialog box.
4. Repeat the three steps above until you are satisfied with the element colors.
5. Select **OK** to change the colors and exit the dialog box. These colors are not restored on boot up.

Save is used to save the current color settings. These are the colors that will be displayed on **Reset** or boot up.

Save cannot be used in conjunction with **Edit...**.

Reset returns the display to the last colors that were saved.

Choose Font ...

This command is available when the WGL Working Wave is the active window. Opens the Font dialog box (figure 3-33), which allows you to select the font of the text in the WGL Working Wave window.

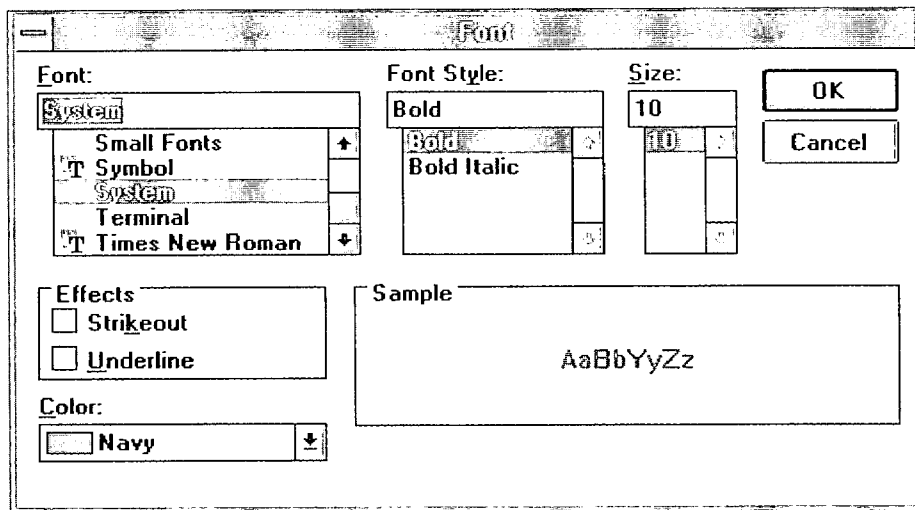

Figure 3-33. Font Dialog Box

Toggle Ribbon

Turns the toggle ribbon on and off. The toggle ribbon is located just below the menu bar. It provides easy access to commands that are used frequently. The toggle ribbon contains the following commands:

-
-
-
-
-
-

See the introduction to this chapter for an explanation of the commands in the toggle ribbon.

WGL Menu

The WGL menu (figure 3-34) allows you to open windows showing the status of WGL settings and the contents of the stack. Commands are also provided for working with WGL programs.

A brief description for each command is provided in the following paragraphs. For more information about using the commands in this menu, see the *HP 8791 Waveform Generation Language Reference*.

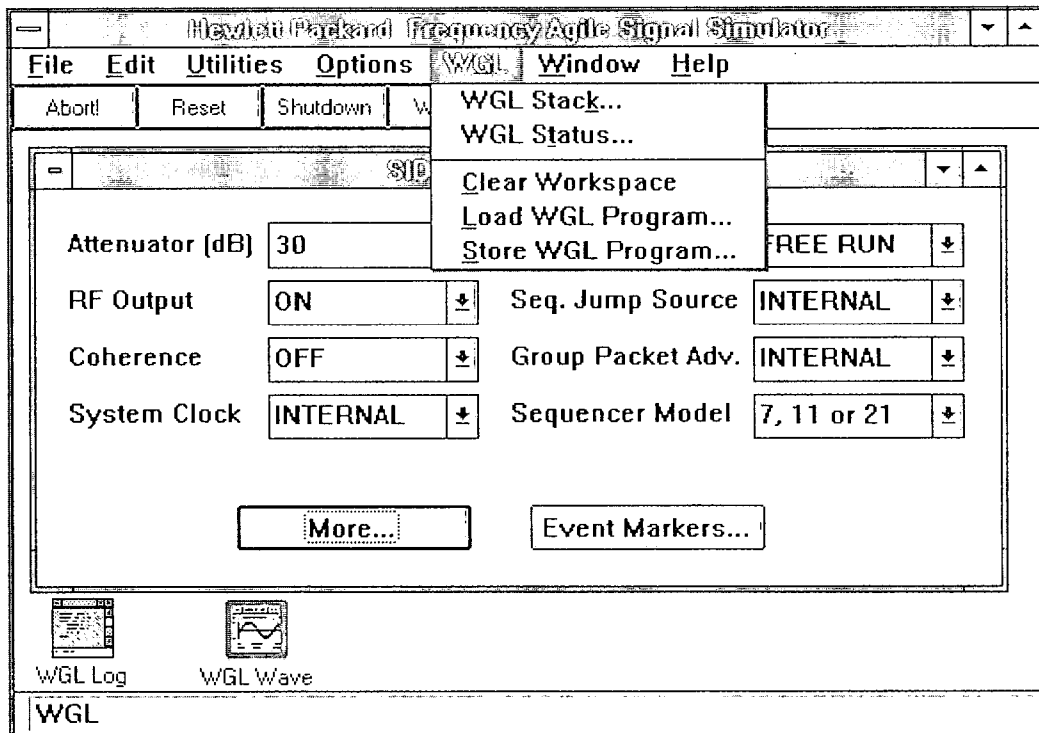

Figure 3-34. WGL Menu

WGL Stack ...	Opens a window displaying the internal WGL stack.
WGL Status ...	Opens a window displaying the internal WGL status.
Clear Workspace	Removes all the current variables and user definitions from the WGL environment.
Load WGL Program ...	<p>Opens the Load WGL Program dialog box. The dialog box lists the WGL programs in the current directory. You can change directories and select a WGL program that has been saved as an ASCII text file or select a compiled WGL program (one that has been saved with the Store WGL Program ... command). Typically, WGL programs saved as ASCII text have a .WGL extension and compiled WGL programs have a .CWC extension.</p> <p>Once selected, the program is loaded directly into the WGL environment. The workspace is cleared before loading a WGL program with a .CWC extension. ASCII text files are appended to the definitions in the workspace.</p>
Store WGL Program ...	<p>Opens the Store WGL Program dialog box. This command saves a WGL program in compiled form, which significantly decreases the time it takes to load a WGL program. Once a program has been stored, it cannot be modified. Stored WGL programs have a .CWC extension.</p>

Window Menu

The Window menu (figure 3-35) provides commands that allow you to manage open windows.

Below the commands is a numbered list of open windows. Selecting one of these windows makes it the active window. The active window is indicated in the list by a check mark.

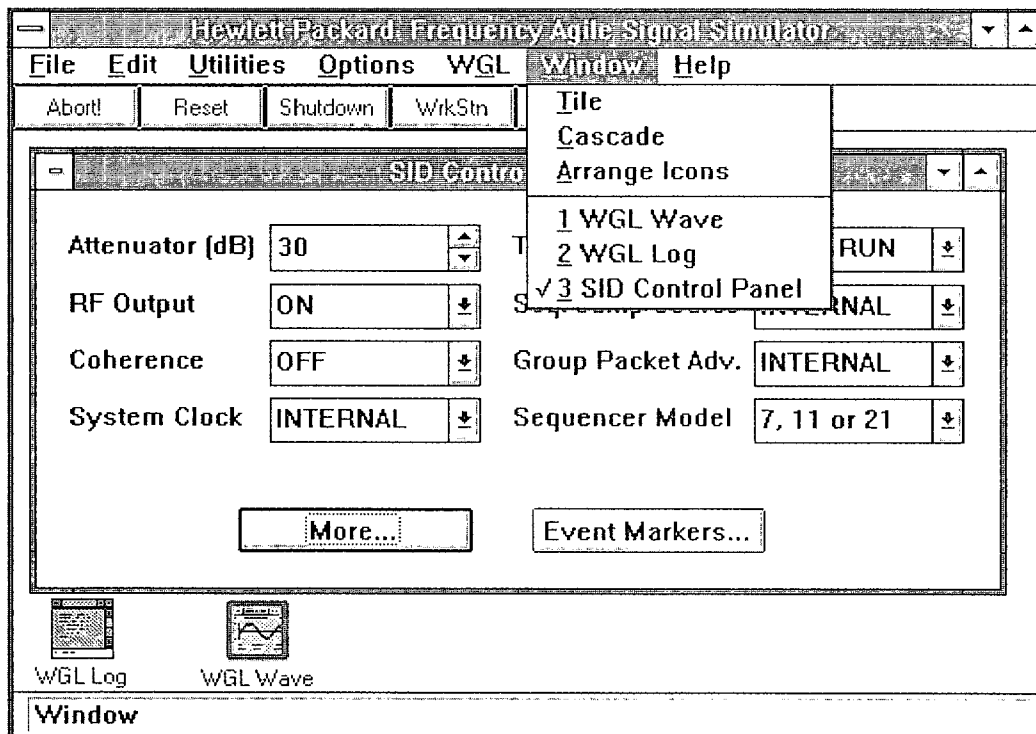

Figure 3-35. Window Menu

- Tile** Arranges the open windows side-by-side so that each window is visible.
- Cascade** Arranges the open windows so that they overlap, but the title bar of each window is visible.
- Arrange Icons** Arranges the icons in rows.

Help Menu

The Help menu (figure 3-36) provides commands that allow you to run an online tutorial and to check the software version. It also provides commands to access online error messages and summary of WGL commands.

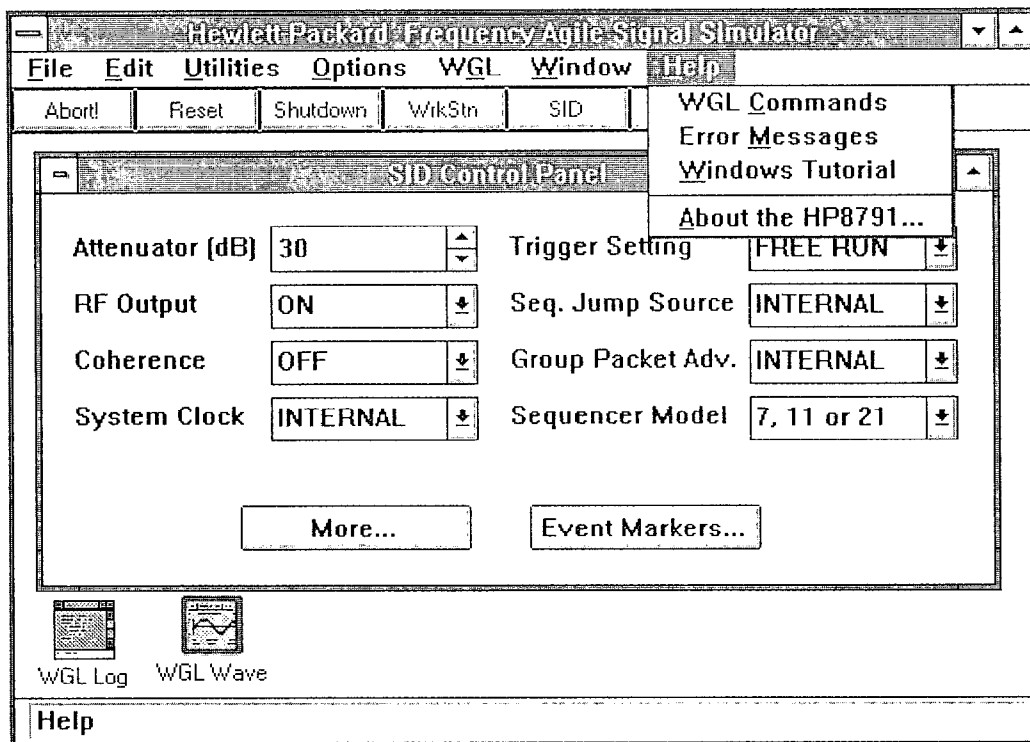

Figure 3-36. Help Menu

WGL Commands	Provides a summary of WGL commands.
Error Messages	Provides an online listing of SID, PSID, WGL, and HP FASS error messages. The online error messages can be accessed even while HP FASS is in remote mode.
Windows Tutorial	Runs the online Microsoft Windows tutorial. Explains Windows basics and how to use a mouse.
About the HP8791 ...	Opens a dialog box that provides information about the software version and release date.

Error Messages

Error messages are read using the :SYST:ERR? query. See “System Subsystem” for additional information about this query.

0 No error.

No action required.

1 The system is placed into an interrupted state.

The system received a new command or was addressed to talk before it finished responding to a query. Check that the controller is programmed to read the query response before issuing the next command.

2 The system is placed into an unterminated state.

Ensure the controller sends the system <NL> (new line) and EOI before addressing the system to talk.

3 The system is placed into a deadlock state.

Send the system eight or less queries in one command line.

4 A query was executed when an indefinite query message has already been defined in the current message record.

Send “*IDN?” and queries that return indefinite length block data as the last query of a command line.

- 5 **The system is addressed to talk but has nothing to say.**
Send the system a valid query before attempting to read query data.
- 10 **Decimal data is out of range.**
Re-enter the HP-IB command using decimal data within the allowable range for that command.
- 20 **Invalid mnemonic.**
See the *PSID Remote Reference* for a list of valid HP-IB mnemonics.
- 21 **Undefined data type.**
Six data types are defined by IEEE Standard 488.2: character, decimal numeric, nondecimal numeric, string, arbitrary block, and expression. Re-enter the HP-IB command using the correct data type.
- 22 **Invalid data field separator.**
Use commas (,) to separate data fields and use a space to separate an HP-IB mnemonic from the data field.
- 23 **Empty data field within a message unit.**
The system received an HP-IB command that contained two commas with no data in between. Either add data between the commas or delete one of the commas.
- 24 **Character data is not allowed for the entered mnemonic.**
Re-enter the HP-IB command using the correct type of data.
- 25 **Character data overflow.**
Character data must be 12 or less characters.

26 **Invalid character within a character data type field.**

Valid character data characters are upper and lower case letters, 0 through 9, and underscore (-).

27 **Undefined character data.**

Re-enter the HP-IB command using valid data for the command.

28 **Improper string data type termination.**

Terminate string data with either single (') or double (") quotation marks. The terminator must be the same as the leading delimiter.

29 **String data is not allowed for the entered mnemonic.**

Re-enter the HP-IB command using the correct type of data.

30 **Block data is not allowed for the entered mnemonic.**

Re-enter the HP-IB command using the correct type of data.

31 **Invalid block type.**

IEEE Standard 488.2 defines two types of block data: definite length and indefinite length. Definite length block data begins with a # and is followed by a non-zero digit indicating the number of length bits that follow. Indefinite length block data begins with #0. For additional information, see the description in this manual of the command in question or IEEE Standard 488.2.

32 **Improper block data termination.**

Terminate block data with EOI asserted while the <NL> character is being sent on the bus.

- 33 **Non-decimal numeric data is not allowed for the entered mnemonic.**

Re-enter the HP-IB command using the correct type of data.

- 34 **Invalid non-decimal numeric data character.**

Valid characters for binary data are 0 and 1. Valid characters for octal data are 0-7. Valid characters for hexadecimal are 0-9 and A-F.

- 35 **Non-decimal numeric data overflow.**

Non-decimal numeric data must contain 8 bytes or less.

- 36 **Improper non-decimal numeric data type terminator.**

Use commas (,) to separate data fields, use a semicolon (;) to separate commands, and <NL> or <EOI> to terminate program messages.

- 37 **Decimal data is not allowed for the entered mnemonic.**

Re-enter the HP-IB command using the correct type of data.

- 38 **Improper decimal data type format.**

Re-enter the HP-IB command using the correct data format.

- 39 **Improper character within decimal data type field.**

Use only 0 through 9, E or e, . (period), + (plus sign), - (minus sign) and (white space).

- 40 **Decimal data type exponent overflow.**

The exponent value must be between -32000 and +32000.

41 **Decimal data suffix is not allowed for the entered mnemonic.**

Re-enter the HP-IB command with the decimal data in fundamental units and omit the suffix.

42 **Invalid decimal data suffix.**

Re-enter the HP-IB command using a valid suffix for the data. You can also enter the decimal data in fundamental units, such as hertz or seconds, and omit the suffix.

45 **Query is not allowed for the current mnemonic.**

Re-enter the command, deleting the ?.

46 **GROUP Execute Trigger in middle of message record.**

Delete the GROUP Execute Trigger BUS command from the program. HP FASS does not respond to this command.

47 **Improper non-decimal data field.**

Re-enter the HP-IB command using data that is valid for the command.

48 **Improper expression data type termination.**

Terminate expression data with a parenthesis. Use a comma to separate data fields, a semicolon to separate commands, and a <NL> or <EOI> to terminate the message.

49 **Expression data is not allowed for the entered mnemonic.**

Re-enter the HP-IB command using the correct type of data.

51 **Invalid character received within a definite length block field.**

Re-enter the HP-IB command using the correct number of data bytes for definite length block data.

60 **Improper number of data fields in message unit.**

Re-enter the HP-IB command using the number of data fields that are required by the command.

61 **Message unit is missing one or more data fields.**

Re-enter the HP-IB command using the number of data fields that are required by the command.

62 **Numeric data buffer overflow.**

Number is too large or has too many digits. Re-enter the HP-IB command with valid data.

63 **String data buffer overflow.**

String data has too many characters. Re-enter the HP-IB command with valid data.

64 **String data type field is expected.**

Re-enter the HP-IB command using string data.

65 **Decimal data type field is expected.**

Re-enter the HP-IB command using decimal data.

66 **Block data type field is expected.**

Re-enter the HP-IB command using block data.

- 67 **Block data type has overrun the destination buffer.**
See command description in manual regarding format of this block of data.
- 68 **Block data has underrun the destination buffer.**
See command description in manual regarding format of this block of data.
- 69 **Format error.**
Re-enter the HP-IB command using the correct format for the command.
- 70 **Character data type field is expected.**
Re-enter the command using character data.
- 71 **An empty string data field was received.**
Re-enter the HP-IB command using valid data.
- 72 **An empty block data field was received.**
Re-enter the HP-IB command using valid data.
- 100 **A command was received from front panel while BUS was in remote mode.**
Enter the HP-IB command over the BUS or put the bus in local mode.
- 101 **A command was received over the BUS while the BUS was in local mode.**
Put the BUS in remote mode and re-enter the HP-IB command.

- 102 **Parallel port transfer failed due to a port timeout.**
Re-enter the HP-IB command.
- 201 **Start address out of range.**
Valid start addresses are 0 to 262143 in multiples of 4 for AM, PM2, and PM memories and PULS field; 0 to 32767 in multiples of 2 for the AUC and FLC fields; 0 to 65535 for the FM memory and the ACS field.
- 202 **File size out of range for this memory.**
Maximum file size is 262144 for AM, PM, and PM2 memories and FLC field; 32768 for AUC and FLC fields; 65536 for FM memory.
- 203 **Illegal HP-IB address specified.**
Valid addresses are 0 through 30.
- 204 **Illegal setting number specified.**
Valid ID setting numbers are 1 through 12
- 206 **Illegal filename**
Filenames must be six characters or less. Valid characters are A-Z, a-z, 0-9, and -. The first character of a filename must be alpha.
- 207 **Illegal advance mode specified.**
Valid loop advance modes are 0 for AUTO, 1 for BUS and 2 for GROUP. Packets have additional advance modes of 3 for BUS IMMEDIATE, 4 for GROUP IMMEDIATE. See the DATA, PCKM, PCLM and SLP commands in the "FASS Subsystem" chapter.

209 **Illegal memory specified.**

Valid memories are ACS, AM, AUC, FLC, FM, PM, PM2, and PULS. See MEM command in the "FASS Subsystem" chapter.

210 **Illegal external clock frequency.**

The system accepts 110 to 160 MHz. See the CEXT command in the "FASS Subsystem" chapter.

211 **Illegal number of scans for packet.**

Valid number of scans are 1 to 65536 for AUTO advance mode and 0 to 65536 for other advance modes. See the DATA, PCKM, PCLM, and SLP commands in the "FASS Subsystem" chapter.

212 **Illegal marker value specified.**

See the MARK command in the "FASS Subsystem" chapter.

214 **Illegal CW frequency or amplitude.**

Valid Model 7 CW frequency is 0 to 67 MHz; valid amplitude is -100 to +10 dBm.

Valid Model 11 CW frequency is 2 MHz to 3.05 GHz; valid amplitude is -107 to +22 dBm.

Valid Model 21 CW frequency is 10 MHz to 19 GHz; valid amplitude is -100 to +10 dBm.

216 **Not valid in this trigger mode.**

This error usually occurs when you try to use a triggered function while the system is in free run mode. See the "Trigger Subsystem" chapter.

- 218 **Illegal SID special function specified.**
See the SPEC command in the “SID Subsystem” chapter for a list of legal special functions.
- 219 **Illegal image number specified.**
Valid hardware image numbers are 0 through 5.
- 220 **Illegal test mode specified.**
See *HP FASS System Service Manual*.
- 221 **No stretch factor for this memory.**
A stretch factor is allowed for AM, PM, and PM2 memories only. See the SFAC command in the “FASS Subsystem” chapter.
- 222 **No phase format for this memory.**
Degrees and radians can be selected for PM and PM2 memories only.
- 225 **Illegal stretch factor specified.**
Valid stretch factors are 1, 2, and 4. See the SFAC command in the “FASS Subsystem” chapter.
- 226 **Zero value returned by the AUC detector.**
See *HP FASS System Service Manual*.
- 227 **Calibration error: bad detector voltage.**
See *HP FASS System Service Manual*.

228 **No Upconverter present.**

Check that Broadband Microwave Upconverter is present and all cables are connected. If the problem persists, see the *HP E2500A Supplemental Information* for options K01, K02, or K09.

229 **No LO Present.**

Check that LO is present and all cables are connected. If the problem persists, see the *HP E2500A Supplemental Information* for options K01, K02, or K09.

231 **Size specified does not match data sent.**

This error occurs when using the :FASS:DATA 'SEQ2' command. The number of packets sent does not match the number of packets specified. See the DATA command in the "FASS Subsystem" chapter.

232 **Illegal number of packets specified.**

While using the :FASS:DATA 'SEQ2' command, too many packets have been specified. The maximum number of packets and loop packets allowed per memory is 32768.

233 **Incomplete or partial data transferred.**

Incorrect number of bytes loaded. Data should be 8-byte real numbers. Occurs when executing the :WGL:WAVE or :FASS:DATA 'SEQ2' commands and the total length of the data sent is not a multiple of 8.

234 **Illegal command for current system model.**

This error occurs when you attempt to execute an HP-IB command which is valid for HP FASS Model 11 mode only, on a HP FASS Model 10. Check description and comments for command.

235 **Invalid HP-IB string data.**

This error usually occurs when you send string data and there is a format error in the string or the sting data is not one of the valid selections. See the DATA, ESEL, and SEQ:IMAG commands in the “FASS Subsystem” chapter.

236 **Download data out of range.**

Correct the data values so that they do not exceed the maximum amount allowed for the modulation memory to which you are trying to download. See the DATA command in the “FASS Subsystem” chapter.

237 **Address Out not allowed for this sequence mode.**

Setting the memory address out to on (:FASS:AOUT ON command) is not allowed if the sequence mode is set to local, master, individual, or external address.

238 **WGL program overflow - file too large.**

This error occurs when using the :WGL:LOAD command. Do not load a file that contains more than 60K characters.

239 **WGL array overflow.**

This error occurs when using the :WGL:WAVE command and attempting to load an amount of data that exceeds the maximum size of the WGL Working Wave. The maximum default size is 65536.

241 **Unable to complete level calibration.**

The level calibration procedure could not be completed because the proper level could not be reached at too many frequencies. See the WGL command log for more information.

242 **Some frequencies could not be calibrated.**

During the calibration procedure, the proper level could not be reached at some frequencies. See the WGL command log for a list of upconverter bands that could not be calibrated.

265 **Cal factor is out of range.**

When entering cal factor values using special functions, the cal factor must be between 0 and 1.

266 **Invalid HP-IB index.**

This error usually occurs when entering one or more commands that have several parameters and too few or too many parameters are given. Check that the required number of parameters are entered.

272 **Illegal cal factor index specified.**

Valid cal factor indexes for the :FASS:CTAB? query are 0 to 728.

401 **Illegal carrier frequency.**

Legal values for carrier frequency are 0 to 67 MHz for Model 7 hardware, 2 MHz to 3.05 GHz for Model 11 hardware, and 10 MHz to 19 GHz for Model 21 hardware. An external upconverter can be used to extend the frequency range.

402 **Illegal AM modulating frequency.**

Valid AM modulating frequency ranges from 0.0625 Hz to 20 MHz.

- 403 **Illegal PM modulating frequency.**
Valid PM modulating frequency ranges from 0.0625 Hz to 20 MHz.
- 404 **Illegal FM modulating frequency.**
Valid FM modulating frequency ranges from 0.0625 Hz to 20 MHz.
- 405 **Illegal duty cycle.**
Legal values for duty cycle are 0 to 100%.
- 406 **Illegal delay.**
Legal values for delay are 0 to the period of the modulating frequency.
- 407 **Illegal AM depth.**
Legal values for AM modulation depth are 0% (no modulation) to 500000% (infinite).
- 408 **Illegal PM peak deviation.**
Legal values for PM peak deviation are 0 to 180 degrees.
- 409 **Illegal FM peak deviation.**
Legal values for FM peak deviation are 0 Hz to 67 MHz. Hardware limits the bandwidth.
- 410 **Illegal frequency hopping peak deviation.**
Check that specifications for current hop pattern are in proper range.
- 411 **Illegal phase offset.**
Legal values for phase offset are -180 to +180 degrees.

412 Illegal carrier frequency offset.

Legal values for carrier frequency offset are -200 GHz to +200 GHz. However, the carrier frequency minus the frequency offset must be between 0 Hz and 67 MHz for HP FASS Model 7, 2 MHz and 3.05 GHz for HP FASS Model 11, and 10 MHz and 19 GHz for HP FASS Model 21.

413 Illegal frequency hopping dwell time.

Legal values for dwell time are 120 ns to 16 seconds.

414 Illegal carrier level.

Legal values for carrier level are -100 to +10 dBm for Model 7 hardware, -107 to +22 dBm for Model 11 hardware, and -100 to +10 dBm for Model 21 hardware.

415 Illegal external clock frequency.

Legal range is 110 to 160 MHz. However, performance specifications are only valid for an external clock frequency of 120 to 140 MHz.

416 Illegal special function.

The specified function does not exist. Use the Special Functions command in the Options menu to review the list of special functions.

417 Illegal user pattern size.

The first number in a user pattern must specify the number of data points to follow. This number must be between 1 and 8192.

418 User pattern not installed.

Install user pattern on removable cartridge.

419 Frequency hopping dwell set to limit.

The currently set dwell is too high for the number of pattern points, and has been automatically reset to the limit. Check the number of hop frequencies and the number of user pattern points.

420 Illegal frequency hopping dwell for number of points.

Frequency hop patterns can be up to 16 seconds long and have up to 8192 frequencies. For patterns with more than 2048 frequencies, actual dwell times above 1.95 ms are limited. Reduce either the hop dwell time or the number of frequencies in the user pattern.

421 Duty cycle is less than the minimum.

For frequencies less than 4 kHz, the minimum duty cycle is 0.012%. For frequencies greater than 4 kHz, the minimum duty cycle is $100[\text{frequency}/(\text{clock_frequency})/4]$.

422 Duty cycle is greater than the maximum.

For frequencies less than 4 kHz, the maximum duty cycle is 99.988%. For frequencies greater than 4 kHz, the maximum duty cycle is 100% minus the minimum duty cycle.

423 Illegal combination of carrier frequency and frequency offset.

Carrier frequency minus frequency offset must be between 0 and 67 MHz for Model 7 hardware, 2 MHz and 3.05 GHz for Model 11 hardware, and 10 MHz and 19 GHz for Model 21 hardware.

- 424 **Illegal carrier level for AM depth.**
Carrier level is too high for currently specified AM depth. Decrease level or depth.
- 425 **Illegal modulating frequency with cubic expand.**
The modulating frequency is out of range for cubic spline expansion of the pattern. Reduce the modulation frequency.
- 805 **Unable to allocate memory.**
The Windows environment does not have enough memory left to run the application. Close other applications or reboot the system.
- 808 **Alphanumeric string expected.**
Enter alphanumeric string (letters and numbers).
- 809 **Numeric input expected.**
Enter numbers.
- 810 **Numeric entry out of range.**
See appropriate command for limits.
- 826 **File already exists.**
Use a different, unique file name.
- 829 **File contains invalid data.**
Replace file.
- 830 **Error reading application resource file.**
See *HP FASS System Service Manual*.

- 831 **Co-processor not responding.**
See *HP FASS System Service Manual*.
- 832 **Cannot create directory.**
There may be a problem with the disk.
- 833 **Cannot delete file.**
There may be a problem with the disk.
- 834 **Unable to compress data enough to fit on flexible disk for hardware image.**
Copying a complete hardware image can require as much as 2.8 MBytes of memory, depending on the image, but typically requires in the range of 600 KBytes. This error occurs when the hardware image cannot be compressed enough to fit on a floppy disk. No data is saved on the floppy disk.
- 913 **Cannot access file.**
Specify file name correctly. There may be a problem with the disk.
- 914 **Cannot append to file.**
There may be a problem with the disk.
- 920 **Error occurred in recalling hardware image register.**
Check that HP-IB cables are securely fastened. Try again. There may be a problem with the disk.
- 921 **Error occurred in saving hardware image register.**
Check that HP-IB cables are securely fastened. Try again. There may be a problem with the disk.

- 922 **Empty hardware register specified.**
Specify a valid hardware image register.
- 923 **Hardware register out of range.**
Valid hardware image registers are 0 through 5.
- 924 **Could not download to hardware.**
See HP FASS System Service Manual.
- 925 **ID setting register out of range.**
Valid ID setting numbers are 1 to 12.
- 926 **Empty ID setting register specified.**
Specify a valid ID setting.
- 931 **Label specified is too long.**
Shorten label.
- 932 **Incorrect floppy type in drive.**
Use a 3.5 inch, high density 1.44 MByte floppy disk.
- 933 **No hardware image found.**
Verify installed hardware images. Image files are missing.
Ensure that all image files are present.
- 934 **No ID setting found.**
Verify installed ID settings. ID setting files are missing.
Ensure that all ID setting files are present.
- 937 **Pattern specified does not exist.**
Specify a valid user pattern.

938 **Cannot delete file.**

Check that the file exists and can be accessed. There may be a problem with the disk.

939 **Maximum number of patterns exist.**

Delete a user pattern if you want to install this one.

940 **Bad pattern data.**

Check user pattern data.

942 **Too much data for hardware image.**

The system received a file that doesn't contain a hardware image and the file is too long. Send system a valid hardware image file.

943 **Not enough data for hardware image.**

The system received a file that doesn't contain a hardware image and the file is too small. Send system a valid hardware image file.

944 **Incorrect file type.**

File must contain ID setting, hardware image, or user pattern.

945 **Too much data for current ID setting.**

The system received a file that doesn't contain an ID setting and the file is too long. Send system a valid ID setting file.

946 **Not enough data for current ID setting.**

The system received a file that doesn't contain an ID setting and the file is too small. Send system a valid ID setting file.

947 **File requested does not exist.**

Specify a valid file.

949 **Printer timed out or not on line.**

953 **Download error**

Check that the DMA cable is connected.

955 **Out of internal pattern memory.**

Too many large patterns are being used by the application. Use smaller or fewer user patterns.

958 **System does not contain pattern.**

This error can occur while using the RSID or PSID application. A user pattern was unable to be saved with the ID setting.

962 **Front panel input request while in remote.**

A WGL program running over HP-IB is trying to get input data from the front panel. Rewrite the program so that it does not request front panel input or script the responses.

963 **Application has been closed.**

An application was closed from the front panel and it is trying to be accessed over HP-IB. Open the application and then access it.

964 **Filename or path specified is too long.**

The path and filename must be less than 64 characters.

965 **Directory specified does not exist.**

966 **No filename specified.**

Specify a valid file name.

967 **Specified file already exists.**

This error only occurs over HP-IB. A compiled WGL program with a .CWC extension is trying to be stored to a file that already exists. Specify another file name or store the file from the front panel.

968 **Error in loading compiled WGL code.**

Try again. Make sure the code is good. It is possible that the .CWC file is defective. There may be a problem with the disk.

970 **Error in loading WGL program file.**

An error occurred while transferring a WGL file from the removable cartridge to HP FASS memory. Try again. If the problem persists, there may be something wrong with the system.

973 **Invalid real data loaded in Working Wave.**

This error occurs when attempting to load invalid real data into the WGL Working Wave. Zeroes will be loaded into the Working Wave to correct the problem. This error can be caused by trying to load a .WAV file that does not contain real numbers or attempting to use the :WGL:WAVE command with an incorrect data type.

1501 **No more program space left.**

There is no more room to create definitions. Clear the WGL workspace.

1502 **No more variable space left.**

There are too many variables created using the STORE command. Clear the WGL workspace.

1504 **Expected variable reference.**

STORE not followed by a variable name. Make sure that it isn't a user definition or internal command name.

1505 **Context mismatch.**

See the SIZE command. The window or context was set to an illegal value.

1506 **String overflow.**

Do not enter more than 250 characters on the command line.

1507 **Invalid window ... check context.**

Either the window is invalid or context size is out of range. Window must be smaller than the size specified with CTX. Valid context values are 2 to 65536.

1508 **Inconsistent parameter.**

Values on the stack are of incorrect type for this operation. Example: Trying to add a string to a number.

1509 **Invalid numeric entry.**

Number on stack is out of range for the operation. Example: Specifying a clock rate of -10 Hz.

1517 **File not found.**

Source file for COPY not found.

- 1520 **No more space on mass storage device.**
- 1522 **Nonexistent file on mass storage.**
File name specified was not found. Example: Purging a file that does not exist.
- 1523 **File has inconsistent type for operation.**
This error occurs when an attempt is made to copy data from one modulation memory to another (for example, trying to copy an FM file to the AMPM memory).
- 1530 **Error detected in processing definition.**
Usually associated with mismatched parentheses which didn't get caught until executing the definition.
- 1531 **Unmatched parentheses.**
Detected error while the input line was being checked.
- 1532 **Invalid repeat syntax.**
Check to see that equal sign is preceded by a valid variable name.
- 1533 **Undefined WGL reference.**
A call was made to a WGL definition or WGL variable that does not exist. Most likely cause is a spelling error.
- 1534 **A-E, AA-EE, X reserved for waveforms.**
Do not try to store a numeric value into a variable that can only contain waveforms.

1535 **Strings cannot be stored.**

Tried to store a string in a variable. Strings can not be stored away.

1536 **Store waveforms in A-E, AA-EE, or X.**

Store waveforms in variables that are reserved for waveforms.

1538 **EVAL requires waveform register on stack.**

A waveform register containing the new X values must be on the top of the stack for this operation to work.

1540 **INSECS/SECS not available in frequency.**

These commands are only defined in the time domain.

1542 **System required for this operation.**

Make sure all hardware is turned on and connected to the Smart Interface. Reset the system.

1543 **Invalid sequence description.**

Working wave does not have the correct format for use with the SEQ2 command.

1546 **Wave not found.**

Select correct storage device.

1547 **Files must be of the same type.**

Copy waveform files of the correct type to the MDS modulation memories. (For example, copy .AM files to AMPM memory, .FM files to FM memory, etc.)

- 1548 **Duplicate file names.**
A file with the same name already exists in storage device.
- 1549 **Invalid definition name.**
WGL definition names should be 10 characters or less. Valid characters are A-Z, 0-9. There should be no other text on the line.
- 1550 **Invalid mass storage name.**
Storage device or directory does not exist.
- 1553 **Illegal context size for Fast Fourier Transform.**
Context size must be a power of two.
- 1557 **Improper memory active for this command.**
Displayed when the AM_MODE or PM_MODE commands are issued and the active memory is not the AMPM_MEM.
- 1558 **WGL clock out of range.**
Allowable range is 110 to 160 MHz for FASSFREQ command.
- 1559 **Pattern file exceeds maximum WGL context.**
Make sure size of pattern file does not exceed 65536 points.
- 1580 **Duplicate HP-IB addresses for SYNCSTART.**
Two slave HP FASS systems have the same address. Change the address on one slave. Do not use HP-IB addresses of 714-717.

1581 **Copy error.**

An error occurred while a file was being copied. The copy was probably not completed.

1582 **Invalid directory.**

WGL tried to access a directory that does not exist.

1583 **Directory not deleted.**

Directory cannot be deleted.

1584 **Inconsistent array sizes for APF file.**

The AUC array must be the same size as the FLC array. The Pulse array must be eight times as large as the AUC and FLC arrays. Register A=AUC; Register B=FLC; Working Wave=Pulse.

1585 **File not copied.**

MS-DOS error.

1586 **File not deleted.**

MS-DOS error.

1587 **Directory not created.**

MS-DOS error.

1588 **Recompile definition source code.**

An attempt was made to load a *file.CWC* into WGL. This file is not compatible with the current version of WGL. Recompile *file.WGL*.

- 1590 **Vector size out of range.**
Resizing of WGL array cannot be done. Use a smaller size.
- 1591 **Total vector size too big.**
An attempt was made to resize more than one WGL array. Total amount of space required for resizing is greater than the space available.
- 1593 **Error occurred while loading WGL program.**
Correct errors in program, clear workspace, and reload program.
- 1594 **WGL command not implemented.**
Some WGL workstation commands are not implemented in WGL on the Smart Interface.
- 1595 **Copy file not allowed.**
This occurs when data is copied from disk to the HP FASS modulation memories and an attempt is made to save the data in a different format (for example, saving .AM data as .FM). This error can also occur if a directory that does not support copying is selected.
- 1596 **Copy wave not allowed.**
This occurs when data is copied from the HP FASS modulation memories to disk and an attempt is made to save the data in a different format (for example, saving .AM data as .FM)
- 1599 **Unexpected system error.**
Reboot system.

2306 **AUC A/D failure.**

See *HP FASS System Service Manual*.

2307 **AUC phase-lock loop unlocked.**

See *HP FASS System Service Manual*.

2308 **External frequency standard error in AUC.**

Be sure that you want the AUC Frequency Standard switch set to EXT. Verify that an external frequency standard is connected to the FREQUENCY STANDARD INPUT. Also check that the external standard is within the specified tolerance. If problem persists, see the *HP FASS System Service Manual*.

2405 **No AUC at specified address.**

Check that AUC HP-IB address is set to 15 and that the HP-IB cables are securely fastened. If problem persists, see the *HP FASS System Service Manual*.

2407 **Unit at address is not an AUC.**

Check that the only instrument in the system with an HP-IB address of 15 is the AUC.

2425 **AUC I/O timeout.**

Check that all HP-IB cables are connected. Next, try resetting the system by sending the *RST command. If the error is still not cleared, try turning the AUC power off and then on. If the problem persists, refer to the *HP FASS System Service Manual*.

- 2601 **Invalid PM memory file name.**
Filenames must be six characters or less. Valid characters are A-Z, a-z, 0-9, and `_`. The first character of a filename must be alpha.
- 2602 **PM memory file could not be opened.**
Possible causes are too many files have been created, no more room for data, or a file is already open.
- 2604 **Data being downloaded to the PM memory is out of range.**
Valid data for PM memory is -180 to +180 (degrees format) or $-\pi$ to $+\pi$ (radians format). See the DATA command in the “FASS Subsystem” chapter.
- 2605 **Unexpected data type encountered when loading data into PM memory.**
Numeric data is expected. See the DATA command in the “FASS Subsystem” chapter.
- 2606 **Out of memory. There is not enough room to store the file in the PM memory.**
PM memory holds a maximum of 262144 data points. See the DATA command in the “FASS Subsystem” chapter.
- 2607 **File not found in PM memory.**
Do not attempt to purge a non-existent file.
- 2610 **The address given for downloading data by address into the PM memory was not valid.**
Valid addresses for PM memory are 0 to 262140 in multiples of 4. See the DATA command in the “FASS Subsystem” chapter.

- 2620 **File size not multiple of four.**
Size of PM memory must be a multiple of 4.
- 2630 **PM stretch factor is out of range.**
Valid stretch factors are 1, 2 or 4. See the SFAC command in the “FASS Subsystem” chapter.
- 2640 **Illegal PM VSIN or VMAP address.**
Valid addresses are 0 to 262140 in multiples of 4.
- 2641 **Illegal PM VSIN or VMAP length.**
Valid length is 0 to 262144 if stretch factor is 1. See the VMAP and VSIN commands in the “FASS Subsystem” chapter.
- 2642 **Illegal PM VSIN or VMAP start value.**
Legal start values for VSIN are -2.98E8 to +2.98E8.
Legal start values for VMAP are -180 to +180°. See the VMAP and VSIN commands in the “FASS Subsystem” chapter.
- 2643 **Illegal PM VSIN or VMAP stop value.**
Legal stop values for VSIN are -2.98E8 to +2.98E8.
Legal stop values for VMAP are -180 to +180°. See the VMAP and VSIN commands in the “FASS Subsystem” chapter.
- 2644 **Illegal PM VSIN offset.**
Legal offset values for VSIN are -180 to +180°.
- 2645 **Illegal PM VSIN amplitude.**
Legal amplitude (scale) values for VSIN are -180 to +180°.

- 2646 **Illegal PM VSIN offset + amplitude.**
The offset + amplitude (scale) must be between -180 and +180°.
- 2647 **PM VSIN or VMAP out of memory.**
Change address or length parameter. Address + length cannot exceed 262144.
- 2651 **Invalid filename used to load packet data into the PM sequencer.**
Filenames must be six characters or less. Valid characters are A-Z, a-z, 0-9, and `_`. The first character of a filename must be alpha. See the PCKM command in the “FASS Subsystem” chapter.
- 2652 **Illegal address division rate for the PM sequencer.**
Valid address rate dividers are 1 to 65536. See the ARAT command in the “FASS Subsystem” chapter.
- 2653 **Wrong number of arguments.**
The correct number of parameters must be used (usually related to loading PM packet data). See the PCKM and PCLM commands in the “FASS Subsystem” chapter.
- 2654 **The named file could not be found in the PM memory.**
The file specified has not been created in PM memory. See the CAT? and DATA commands in the “FASS Subsystem” chapter.

2656 **Wave segment too short to build a packet.**

PM memory wave segments must be at least 8 points long to build a valid packet. See table 8-1 and the DATA, PCKM, and PCLM commands in the “FASS Subsystem” chapter.

2657 **Overall packet dwell too short.**

Packets for the PM memory must meet minimum dwell time requirements. See table 8-2.

2658 **The PM Sequencer memory is full.**

The maximum number of packets is 32768.

2660 **The address or length used to define a packet was not valid.**

See the PCKM and PCLM commands in the “FASS Subsystem” chapter.

2661 **The address given for a marker was out of range.**

Valid addresses for a PM marker is 0 to 262143 in multiples of 4. See the MARK command in the “FASS Subsystem” chapter.

2662 **Illegal PM sequence command order.**

Command order should be to begin sequence (SEQBEG), create loop packet (LPACK), create packets and loop packets (PCLM, PCKM, LPACK), and end sequence (SEQEND). See these commands in the “FASS Subsystem” chapter.

2663 **Illegal PM sequence number (0-1023).**

Valid sequence numbers are 0 to 1023.

- 2664 **Illegal number of scans.**
Legal number of scans are 1 to 65535 for auto advance mode and 0 to 65535 for bus or group advance mode.
- 2665 **Illegal PM packet dwell.**
See Table 8-2 in the “FASS Subsystem” chapter.
- 2667 **Invalid PM marker delay.**
Valid marker delay ranges from 1 to 64 clock cycles.
- 2669 **Invalid PM sequence end found.**
A sequence has been defined but the end of sequence is missing.
- 2682 **Invalid PM packet number.**
Valid packet numbers are 0 to 32767.
- 2683 **Undefined PM sequence number.**
A command that requires a sequence number parameter is being used, but that sequence number has not been defined.
- 2684 **EDIT:PACK used for loop packet.**
Use the :FASS:SEQ:EDIT:LOOP command to edit loop packets.
- 2685 **EDIT:LOOP used for packet.**
Use the :FASS:SEQ:EDIT:PACK command to edit regular packets.

- 2686 **Illegal edit of loop packet beginning of sequence.**
The sequencer model is probably set to Model 10.
Change the sequencer model to Model 7, 11, or 21.
- 2692 **Out of PM packet memory.**
The maximum number of packets allowed is 32768.
- 2694 **Master sequencer already defined.**
Only one sequencer can be the master sequencer. See
the SEQ:MODE command in the "FASS Subsystem"
chapter.
- 2701 **Invalid file name in the AM or PM2 memory.**
Filenames must be six characters or less. Valid
characters are A-Z, a-z, 0-9 and `_`. The first character of
a filename must be alpha.
- 2702 **File could not be opened in the AM or PM2 memory.**
Possible causes are too many files have been created, no
more room for data, or a file is already open.
- 2704 **Data being downloaded to the AM or PM2 memory was
out of the legal range.**
Valid data for AM memory is -1 to +1. Valid data for
PM2 memory is -180 to +180 (degrees format) or -pi to
+pi (radians format). The entered value is assumed to
be in degrees. See the DATA command in the "FASS
Subsystem" chapter.
- 2705 **Unexpected data type encountered when loading data into
the AM or PM2 memory.**
Numeric data is expected. See the DATA command in
the "FASS Subsystem" chapter.

2706 **Out of memory. There was not enough room to store the file in the AM or PM2 memory.**

AM or PM2 memory holds a maximum of 262144 data points.

2707 **File not found in AM or PM2 memory.**

Do not attempt to purge a non-existent file.

2710 **The address given for downloading data by address into the AM or PM2 memory was not valid.**

Valid addresses for AM and PM2 memory are 0 to 262140 in multiples of 4. See the DATA command in the "FASS Subsystem" chapter.

2720 **File size not multiple of four.**

File size in AM or PM2 memory must be a multiple of four.

2730 **Stretch factor out of range**

Valid stretch settings are 1, 2 or 4. See the SFAC command in the "FASS Subsystem" chapter.

2740 **Illegal AM or PM2 VSIN or VMAP address.**

Valid addresses are 0 to 262140 in multiples of 4.

2741 **Illegal AM or PM2 VSIN or VMAP length.**

Valid length is 0 to 262144 if stretch factor is 1. See the VMAP and VSIN commands in the "FASS Subsystem" chapter.

- 2742 **Illegal AM or PM2 VSIN or VMAP start value.**
Legal start values for VSIN are -2.98E8 to +2.98E8.
Legal start values for VMAP are -1 to +1. See the
VMAP and VSIN commands in the "FASS Subsystem"
chapter.
- 2743 **Illegal AM or PM2 VSIN or VMAP stop value.**
Legal stop values for VSIN are -2.98E8 to +2.98E8.
Legal stop values for VMAP are -1 to +1. See the
VMAP and VSIN commands in the "FASS Subsystem"
chapter.
- 2744 **Illegal AM or PM2 VSIN offset.**
Legal offset values for VSIN are -1 to +1.
- 2745 **Illegal AM or PM2 VSIN amplitude.**
Legal amplitude (scale) values for VSIN are -1 to +1.
- 2746 **Illegal AM or PM2 VSIN offset + amplitude.**
The offset + amplitude (scale) must be between -1 and
+1.
- 2747 **AM VSIN or VMAP out of memory.**
Change address or length parameter. Address + length
cannot exceed 262144.
- 2751 **Invalid filename used to load packet data into the AM or
PM2 sequencer.**
Filenames must be six characters or less. Valid
characters are A-Z, a-z, 0-9, and -. The first character of
a filename must be alpha. See the PCKM command in
the "FASS Subsystem" chapter.

2752 **Illegal address division rate for the AM or PM2 sequencer.**

Valid address rate dividers are 1 to 65536. See the ARAT command in the "FASS Subsystem" chapter.

2753 **Wrong number of arguments.**

The correct number of parameters must be used (usually related to loading AM or PM2 packet data). See the PCKM and PCLM commands in the "FASS Subsystem" chapter.

2754 **The named file could not be found in the AM or PM2 memory.**

Specified file has not been created in AM or PM2 memory. See the CAT? and DATA commands in the "FASS Subsystem" chapter.

2756 **Wave segment too short to build packet.**

Wave segments must be at least 8 points long to build a valid packet. See the DATA, PCKM, and PCLM commands in the "FASS Subsystem" chapter.

2757 **Overall packet dwell time too short.**

Packets in the AM or PM2 memory must meet minimum dwell time requirements. See table 8-2.

2758 **The AM or PM2 sequencer memory is full.**

The maximum number of packets is 32768.

2760 **The address or length used to define a packet was not valid.**

See the PCKM and PCLM commands in the "FASS Subsystem" chapter.

- 2761 **The address given for a marker was out of range.**
Valid addresses for an AM or PM2 marker is 0 to 262140 in multiples of 4. See the MARK command in the “FASS Subsystem” chapter.
- 2762 **Illegal AM or PM2 sequence command order.**
Command order should be to begin sequence (SEQBEG), create loop packet (LPACK), create packets and loop packets (PCLM, PCKM, LPACK), and end sequence (SEQEND). See these commands in the “FASS Subsystem” chapter.
- 2763 **Illegal AM or PM2 sequence number (0-1023).**
Valid sequence numbers are 0 to 1023.
- 2764 **Illegal number of scans.**
Legal number of scans are 1 to 65535 for auto advance mode and 0 to 65535 for bus or group advance mode.
- 2765 **Illegal AM or PM2 packet dwell.**
See Table 8-2 in the “FASS Subsystem” chapter.
- 2767 **Invalid AM or PM2 marker delay.**
Valid marker delay ranges from 1 to 64 clock cycles.
- 2769 **Invalid AM or PM2 sequence end found.**
A sequence has been defined but the end of sequence is missing.
- 2770 **AM or PM2 packet query error.**
See the PCOU? and PFRE? commands in the “FASS Subsystem” chapter.

- 2782 **Invalid AM OR PM2 packet number.**
Valid packet numbers are 0 to 32767.
- 2783 **Undefined AM OR PM2 sequence number.**
A command that requires a sequence number parameter is being used, but that sequence number has not been defined.
- 2784 **EDIT:PACK used for loop packet.**
Use the :FASS:SEQ:EDIT:LOOP command to edit loop packets.
- 2785 **EDIT:LOOP used for packet.**
Use the :FASS:SEQ:EDIT:PACK command to edit regular packets.
- 2786 **Illegal edit of loop packet beginning of sequence.**
The sequencer model is probably set to Model 10. Change the sequencer model to Model 7, 11, or 21.
- 2792 **Out of AM OR PM2 packet memory.**
The maximum number of packets allowed is 32768.
- 2794 **Master sequencer already defined.**
Only one sequencer can be the master sequencer. See the SEQ:MODE command in the "FASS Subsystem" chapter.
- 2801 **Invalid file name in the FM memory.**
Filenames must be six characters or less. Valid characters are A-Z, a-z, 0-9, and -. The first character of a filename must be alpha.

- 2802 **File could not be opened in the FM memory.**
Possible causes are too many files have been created, no more room for data, or a file is already open.
- 2804 **Data being downloaded to the FM memory was out of the legal range.**
Valid data for FM memory is -67108864 to +67108863.875. The entered value is assumed to be in hertz. See the DATA command in the "FASS Subsystem" chapter.
- 2805 **Unexpected data type encountered when loading data into the FM memory.**
Numeric data is expected. See the DATA command in the "FASS Subsystem" chapter.
- 2806 **Out of memory. There was not enough room to store the file in the FM memory.**
FM memory holds a maximum of 65536 data points. See the DATA command in the "FASS Subsystem" chapter.
- 2807 **File not found in FM memory.**
Do not attempt to purge a non-existent file.
- 2810 **The address given for downloading data by address into the FM memory was not valid.**
Valid addresses for FM memory are 0 to 65535. See the DATA command in the "FASS Subsystem" chapter.
- 2840 **Illegal FM VSIN or VMAP address.**
Valid addresses are 0 to 65535.

- 2841 **Illegal FM VSIN or VMAP length.**
Valid length is 0 to 65536.
- 2842 **Illegal FM VSIN or VMAP start value.**
Legal start values for VSIN are -2.98E8 to +2.98E8.
Legal start values for VMAP are -67108864 to +67108864. See the VMAP and VSIN commands in the "FASS Subsystem" chapter.
- 2843 **Illegal FM VSIN or VMAP stop value.**
Legal stop values for VSIN are -2.98E8 to +2.98E8.
Legal stop values for VMAP are -67108864 to +67108864.
- 2844 **Illegal FM VSIN offset.**
Legal offset values are -67108864 to +67108864.
- 2845 **Illegal FM VSIN amplitude.**
Legal amplitude (scale) values are -67108864 to +67108864.
- 2846 **Illegal FM VSIN offset + amplitude.**
The offset + amplitude (scale) must be between -67108864 to +67108864.
- 2847 **FM VSIN or VMAP out of memory.**
Change address or length parameter. Address + length cannot exceed 65536.

2851 **Invalid filename used to load packet data into the FM sequencer.**

Filenames must be six characters or less. Valid characters are A-Z, a-z, 0-9, and -. The first character of a filename must be alpha. See the PCKM command in the "FASS Subsystem" chapter.

2852 **Illegal address division rate for the FM sequencer.**

Valid address rate dividers are 1 to 65536. See the ARAT command in the "FASS Subsystem" chapter.

2854 **The named file could not be found in the FM memory.**

Specified file has not been created in FM memory. See the CAT? and DATA commands in the "FASS Subsystem" chapter.

2856 **Wave segment too short to build packet.**

Wave segments must be at least 2 points long to build a valid packet. See table 8-1 and the DATA, PCKM, and PCLM commands in the "FASS Subsystem" chapter.

2857 **Overall packet dwell time too short.**

Packets in the FM memory must meet minimum dwell time requirements. See table 8-2 and the DATA, PCKM, and PCLM commands in the "FASS Subsystem" chapter.

2858 **The FM Sequencer memory is full.**

The maximum number of packets is 32768.

2860 **Invalid FM packet address or size.**

See the PCKM and PCLM commands in the "FASS Subsystem" chapter.

- 2861 **The address given for a marker was out of range.**
Valid addresses for an FM marker are 0 to 65535. See the MARK command in the "FASS Subsystem" chapter.
- 2862 **Illegal FM sequence command order.**
Command order should be to begin sequence (SEQBEG), create loop packet (LPACK), create packets and loop packets (PCLM, PCKM, LPACK), and end sequence (SEQEND). See these commands in the "FASS Subsystem" chapter.
- 2863 **Illegal FM sequence number (0-1023).**
Valid sequence numbers are 0 to 1023.
- 2864 **Illegal number of scans.**
Legal number of scans are 1 to 65535 for auto advance mode and 0 to 65535 for bus or group advance mode.
- 2865 **Illegal FM packet dwell.**
See Table 8-2 in the "FASS Subsystem" chapter.
- 2867 **Invalid FM marker delay.**
Valid marker delay ranges from 1 to 64 clock cycles.
- 2869 **Invalid FM sequence end found.**
A sequence has been defined but the end of sequence is missing.
- 2870 **FM packet query error.**
See the PCOU? and PFRE? commands in the "FASS Subsystem" chapter.

- 2882 **Invalid FM packet number.**
Valid packet numbers are 0 to 32767.
- 2883 **Undefined FM sequence number.**
A command that requires a sequence number parameter is being used, but that sequence number has not been defined.
- 2884 **EDIT:PACK used for loop packet.**
Use the :FASS:SEQ:EDIT:LOOP command to edit loop packets.
- 2885 **EDIT:LOOP used for packet.**
Use the :FASS:SEQ:EDIT:PACK command to edit regular packets.
- 2886 **Illegal edit of loop packet beginning of sequence.**
The sequencer model is probably set to Model 10. Change the sequencer model to Model 7, 11, or 21.
- 2892 **Out of FM packet memory.**
The maximum number of packets allowed is 32768.
- 2894 **Master sequencer already defined.**
Only one sequencer can be the master sequencer. See the SEQ:MODE command in the "FASS Subsystem" chapter.
- 2901 **Invalid file name in the FREQ memory.**
Filenames must be six characters or less. Valid characters are upper-case alpha, digits and "_". The first character of a filename must be alpha.

- 2902 **File could not be opened in the FREQ memory.**
Possible causes are too many files have been created, no more room for data, or a file is already open.
- 2904 **Data being downloaded to the FREQ memory is out of the legal range.**
See the DATA command in the HP FASS subsystem for legal data values for the AUC, ACS, FLC, and PULS fields.
- 2905 **Unexpected data type encountered when loading data into the FREQ memory.**
Numeric data is expected. See the DATA command in the "FASS Subsystem" chapter.
- 2906 **Out of memory. There was not enough room to store the file into a frequency field.**
Maximum file size for each field is 65536 points for ACS, 32768 points for AUC and FLC, and 262144 points for PULS. See the DATA command in the "FASS Subsystem" chapter.
- 2907 **File not found in FREQ memory.**
Do not attempt to purge a non-existent file.
- 2908 **Incompatible length for FREQ file.**
This error occurs when data is loaded into the FREQ memory by file name. Make sure that data in the four fields of FREQ memory is in the correct ratio: 1 AUC data point, 1 FLC data point, 2 ACS points, and 8 PULS points.

2910 **The address given for downloading data by address into the FREQ memory was not valid.**

Valid addresses are 0 to 32768 in multiples of 2 for AUC and FLC fields, 0 to 65536 in multiples of 2 for the ACS field, and 0 to 262140 in multiples of 4 for the PULS field. See the DATA command in the "FASS Subsystem" chapter

2920 **Pulse Data Error.**

The number of PULS field data points must be a multiple of four.

2940 **Illegal FREQ VSIN or VMAP address.**

Valid addresses are 0 to 65535.

2941 **Illegal FREQ VSIN or VMAP length.**

Valid length is 0 to 65536.

2942 **Illegal FREQ VSIN or VMAP start value.**

Legal start values for VSIN are -2.98E8 to +2.98E8.
Legal start values for VMAP are -67108864 to +67108864. See the VMAP and VSIN commands in the "FASS Subsystem" chapter.

2943 **Illegal FREQ VSIN or VMAP stop value.**

Legal stop values for VSIN are -2.98E8 to +2.98E8.
Legal stop values for VMAP are -67108864 to +67108864.

2944 **Illegal FREQ VSIN offset.**

Legal offset values are -67108864 to +67108864.

- 2945 **Illegal FREQ VSIN amplitude.**
Legal amplitude (scale) values are -67108864 to +67108864.
- 2946 **Illegal FREQ VSIN offset + amplitude.**
The offset + amplitude (scale) must be between -67108864 and +67108864.
- 2947 **FREQ VSIN or VMAP out of memory.**
Change address or length parameter. Address + length cannot exceed 65536.
- 2951 **Invalid filename used to load packet data into the FREQ sequencer.**
Filenames must be six characters or less. Valid characters are upper-case alpha, digits and “_”. The first character of a filename must be alpha. See the PCKM command in the “FASS Subsystem” chapter.
- 2952 **Illegal address division rate for the FREQ sequencer.**
Valid address rate dividers are 1 to 65536. See the ARAT command in the “FASS Subsystem” chapter.
- 2954 **The named file could not be found in the frequency memory.**
Specified file has not been created in frequency memory. See the CAT? and DATA commands in the “FASS Subsystem” chapter.

2956 **Wave segment too short to make packet.**

Wave segments must be at least 2 points long to build a valid packet. See table 8-1 (ACS memory field) and the DATA, PCKM, and PCLM commands in the “FASS Subsystem” chapter.

2957 **FREQ packet dwell time too short.**

Packets in the FREQ memory must meet minimum dwell time requirements. See table 8-2 and the DATA, PCKM, and PCLM commands in the “FASS Subsystem” chapter.

2958 **The FREQ Sequencer memory is full.**

The maximum number of packets is 32768.

2960 **Invalid FREQ packet address or size.**

See the PCLM and PCKM commands in the “FASS Subsystem” chapter.

2961 **The address given for a marker was out of range.**

Valid addresses for a FREQ marker are 0 to 65535. See the MARK command in the “FASS Subsystem” chapter.

2962 **Illegal FREQ sequence command order.**

Command order should be to begin sequence (SEQBEG), create loop packet (LPACK), create packets and loop packets (PCLM, PCKM, LPACK), and end sequence (SEQEND). See these commands in the “FASS Subsystem” chapter.

2963 **Illegal FREQ sequence number (0-1023).**

Valid sequence numbers are 0 to 1023.

- 2964 **Illegal number of scans.**
Legal number of scans are 1 to 65535 for auto advance mode and 0 to 65535 for bus or group advance mode.
- 2965 **Illegal `FREQ` packet dwell.**
See Table 8-2 in the “`FASS Subsystem`” chapter.
- 2967 **Invalid `FREQ` marker delay.**
Valid marker delay ranges from 1 to 64 clock cycles.
- 2969 **Invalid `FREQ` sequence end found.**
A sequence has been defined but the end of sequence is missing.
- 2970 **`FREQ` packet query error.**
See the `PCOU?` and `PFRE?` commands in the “`FASS Subsystem`” chapter.
- 2982 **Invalid `FREQ` packet number.**
Valid packet numbers are 0 to 32767.
- 2983 **Undefined `FREQ` sequence number.**
A command that requires a sequence number parameter is being used, but that sequence number has not been defined.
- 2984 **`EDIT:PACK` used for loop packet.**
Use the `:FASS:SEQ:EDIT:LOOP` command to edit loop packets.

- 2985 **EDIT:LOOP used for packet.**
Use the :FASS:SEQ:EDIT:PACK command to edit regular packets.
- 2986 **Illegal edit of loop packet beginning of sequence.**
The sequencer model is probably set to Model 10. Change the sequencer model to Model 7, 11, or 21.
- 2992 **Out of FREQ packet memory.**
The maximum number of packets allowed is 32768.
- 2994 **Master sequencer already defined.**
Only one sequencer can be the master sequencer. See the SEQ:MODE command in the "FASS Subsystem" chapter.
- 3005 **No MDS at specified address.**
Check that the MDS HP-IB address is set to 17 and that the HP-IB cables are securely fastened. If problem persists, see the *HP FASS System Service Manual*.
- 3008 **The unit is not an MDS.**
Check that the only instrument in the system with an HP-IB address of 17 is the MDS.
- 3012 **Zero file length specified.**
Length parameter cannot be 0. See the DATA and the PCLM commands in the "FASS Subsystem" chapter.

3015 Illegal packet advance mode.

Valid loop packet advance modes are 0 for AUTO, 1 for BUS and 2 for GROUP. In addition, packets have 3 for BIMM and 4 for GIMM. See the DATA, PCKM, PCLM, and SLP commands in the "FASS Subsystem" chapter.

3020 Number of packets specified as zero.

The first number in the array of sequence data for the :FASS:DATA 'SEQ2' command is the number of packets in the sequence. This number must be something other than 0.

3032 MDS I/O timeout.

Check that all HP-IB cables are connected. Next, try resetting the system by sending the *RST command. If the error is still not cleared, try turning the MDS power off and then on. If the problem persists, refer to the *HP FASS System Service Manual*.

3047 File not found in MDS.

File name specified was not found in modulation memory. Specify a valid file name.

3048 File length is out of range.

See the CONS, DATA, IDAT, PCLM, VMAP, and VSIN commands in the "FASS Subsystem" chapter.

3049 File start address out of range.

See the CONS, DATA, IDAT, PCLM, VMAP, and VSIN commands in the "FASS Subsystem" chapter.

3050 **File length < minimum size to create packet.**

Minimum packet file size that can be used to create a packet is 8 for AM, PM2, and PM memories, 2 for FM memory, and 2 for FREQ memory.

3056 **Address in not the required multiple.**

Addresses in AM, PM, and PM2 memories must be multiples of 4. Addresses in FREQ memory fields must be multiples of 2.

3057 **Size is not the required multiple.**

AM, PM, PM2, and the PULS field in frequency memory must be a multiple of 4. ACS field in frequency memory must be a multiple of 2.

3058 **Illegal file size.**

See the DATA command in the "FASS Subsystem" chapter.

3205 **No ACS at specified address.**

Check that the ACS HP-IB address is set to 16 and that the HP-IB cables are securely fastened. If problem persists, see the *HP FASS System Service Manual*.

3207 **Unit at address is not ACS.**

Check that the only instrument in the system with an address of 16 is the ACS.

3211 **Zero file length specified.**

Specify valid parameter for file length. See the CONS, DATA, IDAT, PCLM, VMAP, and VSIN commands in the "FASS Subsystem" chapter.

3223 ACS I/O timeout.

Check that all HP-IB cables are connected. Next, try resetting the system by sending the *RST command. If the error is still not cleared, try turning the ACS power off and then on. If the problem persists, refer to the *HP FASS System Service Manual*.

3305 No instrument at specified address.

Verify that address being sent matches the instrument address setting. Check that the HP-IB cables are securely fastened.

3308 Illegal HP-IB interface select code.

The select code must be 7.

3309 Illegal HP-IB device address.

Valid HP-IB device addresses are 0 to 30.

3314 EOI was not received at data end.

Ensure that EOI is asserted with the last byte of data.

3332 Instrument I/O timeout.

Make sure that the command string sent is valid for the instrument receiving it. Check that the HP-IB cables are securely fastened. If necessary, reboot the instrument.

3506 AMUC A/D failure.

See *HP FASS System Service Manual*.

3605 No AMUC at specified address.

Check that the AMUC HP-IB address is set to 14 and that the HP-IB cables are securely fastened. If problem persists, see the *HP FASS System Service Manual*.

3625 **AMUC I/O timeout.**

Check that all HP-IB cables are connected. Next, try resetting the system by sending the *RST command. If the error is still not cleared, try turning the AMUC power off and then on. If the problem persists, refer to the *HP FASS System Service Manual*.

5403 **Math accelerator hardware failure.**

See *HP FASS System Service Manual*.

5441 **Math accelerator hardware failure.**

See *HP FASS System Service Manual*.

5507 **Math accelerator hardware failure.**

See *HP FASS System Service Manual*.

5508 **Math accelerator hardware failure.**

See *HP FASS System Service Manual*.

┌

┐

└

┘

Glossary

ACS

Agile Carrier Synthesizer

Agile Signal

The agile signal makes a change in frequency on a pulse-to-pulse basis while the frequency is stable during the pulse.

AM

Amplitude Modulation

AMUC

Agile Microwave Upconverter. It extends the frequency range of HP FASS to 18 GHz.

AUC

Agile Upconverter

Compression

A technique used to achieve the closest modulation frequency HP FASS can produce when the modulation period is too short to accommodate all the user pattern data.

Cubic Spline

An expansion technique for user patterns that is a third-order fit. This technique should be used with user patterns containing non-linear continuous functions.

DMA

Direct Memory Access

Duty Cycle

Percent of the modulation period that an AM rectangular waveform is pulsed on.

Dwell Time

The length of time each frequency in a user hop pattern is output.

ECM

Electronic Counter Measures

ECCM

Electronic Counter-Counter Measures

EW

Electronic Warfare

Expansion

A technique used to achieve the closest modulation frequency HP FASS can produce when there is not enough user pattern data to fill the modulation period.

FLC

Fast Level Control

FM

Frequency Modulation

Frequency Agility

The ability of a system to switch among a number of different operating frequencies.

Frequency Hop Signal

The frequency hop signal is seen at one frequency for a time and then moves to a new frequency. The hop can be manually controlled (slow), and random, or

electronically controlled (faster), and follow a preset pattern.

FRU

Field Replaceable Unit

FSK

Frequency Shift Keying. The shift can be between two different values of frequency.

Hardware Image

Sequencer and memory contents plus hardware configuration data that has been saved to a file.

Hop Signal

See Frequency Hop Signal.

HP-IB

Hewlett Packard Interface Bus

ID

Instrument-on-a-Disc

ID Setting

Front panel settings of an application ID that have been saved to a file. Contains all the information needed to calculate, download, and generate a signal when using an application ID with HP FASS.

Linear Interpolation

An expansion technique for user patterns that is used when the new element's values should vary linearly between entries in a user pattern.

MDS

Modulation Data Source.

PM

Phase Modulation

PSID

Precision Signal Generator Instrument-on-a-Disk.

PSK

Phase Shift Keying

QPSK

Quadrature Phase Shift Keying. The pulsed signal can be phase shifted between four phase values.

Quadrature

Signal separation of 90°

RSID

Radar Simulator Instrument-on-a-Disk.

Sample and Hold

An expansion technique for user patterns that is used when the new element's values should be set equal to the preceding user pattern entry.

SI

Smart Interface

SID

System Instrument-on-a-Disk

Stretching

See Expansion.

User Pattern

An ASCII text file that contains a list of data. Used to customize an application.

Index

- A**
 - abort!, 3-7
 - active memory, 3-28
 - address rate divider, 3-30
 - AM delay, 2-32
 - AM example, 2-7
 - AM memory mode, 3-28
 - AM mod level, 2-28
 - AM mod rate, 2-28
 - amplitude, 2-26
 - AM user pattern, 2-30, 2-35
 - AM waveform, 2-29
 - application workspace, 3-5
 - arrange icons, 3-83
 - attenuator, 3-19
 - auto start, 3-56

- C**
 - calibration, 3-65
 - carrier amplitude, 2-26
 - carrier frequency, 2-25
 - cascade, 3-83
 - choose color, 3-77
 - choose font, 3-78
 - clear, 3-45
 - clear all hardware images, 3-56
 - clear all ID settings, 3-60
 - clear hardware image, 3-56
 - clear ID settings, 3-59
 - clear WGL workspace, 3-81
 - clock rate dividers, 2-19
 - coherence, 3-19
 - compression, 2-19

configure printer, 3-42
continue generating signal, 3-53
control-menu box, 3-4
copy, 3-45
copy ID settings to floppy, 3-60
copy image to floppy, 3-56
copy image to image, 3-56
copy user pattern to floppy, 3-62
cubic spline, 2-19
cut, 3-45
CW signal, 3-64

D data scaling, user patterns, 2-17
delay, 2-36
 AM, 2-32
 PM, 2-39
delete all user patterns, 3-62
delete user patterns, 3-62
diagnostics, 3-63
dwell time, 2-41
dynamic data mode, 3-28

E Edit Menu
 clear, 3-45
 copy, 3-45
 cut, 3-45
 find, 3-45
 find next, 3-46
 find previous, 3-46
 paste, 3-45
 paste to WGL, 3-46
 select all, 3-45
 undo, 3-45
edit user patterns, 3-62
event marker 1, 3-34
event marker 2, 3-34
example
 AM, 2-7
 FM, 2-9
 frequency hop, 2-14

PM, 2-12
expansion modes, 2-19

- F** FASS Busy, 3-9
 - File Menu
 - exit, 3-43
 - new, 3-40
 - open, 3-40
 - print, 3-41
 - printer setup, 3-42
 - save, 3-41
 - save as, 3-41
 - find, 3-45
 - find next occurrence, 3-46
 - find previous occurrence, 3-46
 - FM example, 2-9
 - FM mod rate, 2-33
 - FM waveform, 2-34
 - format floppy disk, 3-11
 - frequency, CW, 2-25
 - frequency hop example, 2-14
 - frequency hop mod rate, 2-41
 - frequency hopping, 2-41
 - frequency hop user pattern, 2-42
 - frequency hop waveform, 2-42
-
- G** generate signal, 2-44
 - group packet advance, 3-20
-
- H** hardware images, 3-54
 - auto start, 3-56
 - clear, 3-56
 - clear all images, 3-56
 - copy image to floppy, 3-56
 - copy image to image, 3-56
 - label, 3-56
 - list floppy, 3-58
 - load image to floppy, 3-57
 - recall, 3-55
 - save, 3-55

IP-IB address, 3-72

- I** icon bar, 3-5
- ID settings, 3-58
 - clear, 3-59
 - clear all settings, 3-60
 - copy settings to floppy, 3-60
 - label, 3-59
 - list floppy disk, 3-60
 - load settings from floppy, 3-60
 - recall, 3-59
 - save, 3-59
- install pattern from floppy, 3-62
- interpolation, linear, 2-19

- L** label hardware image, 3-56
- label ID settings, 3-59
- level calibration, 3-65
- level, carrier, 2-26
- linear interpolation, 2-19
- list floppy, 3-58
- list floppy disk, 3-60
- list user patterns on floppy, 3-62
- load ID settings from floppy, 3-60
- load image to floppy, 3-57
- load WGL program, 3-81

- M** manual contents, 1-5
- marker address, 3-35
- marker delay, 3-35
- maximize button, 3-4
- memory address out, 3-29
- menu bar, 3-5
- minimize button, 3-4
- mode rate
 - frequency hop, 2-41
- mod level
 - AM, 2-28
 - PM, 2-37
- mod rate

- AM, 2-28
- FM, 2-33
- PM, 2-37
- modulation depth
 - AM, 2-28
- modulation frequency
 - AM, 2-28
 - FM, 2-33
 - PM, 2-37
- modulation waveform, 2-29, 2-37
 - FM, 2-34
 - frequency hop, 2-42

- N** new WGL file, 3-40

- O** open WGL file, 3-40
- Options Menu
 - choose color, 3-77
 - choose font, 3-78
 - HP-IB address, 3-72
 - special functions, 3-72
 - toggle ribbon, 3-79
- output attenuator, 3-19

- P** paste, 3-45
- paste to WGL, 3-46
- pause system, 3-53
- peak deviation, 2-33
- peak deviation, PM, 2-37
- phase coherence, 3-19
- phase delay
 - AM, 2-32
 - PM, 2-39
- phase offset, 2-26
- PM data mode, 3-29
- PM delay, 2-39
- PM example, 2-12
- PM mod level, 2-37
- PM mod rate, 2-37
- PM user pattern, 2-38

PM waveform, 2-37
print contents of active window, 3-41
printer setup, 3-42
printers supported by SID, 3-13
print files, 3-41
Program Manager, 3-10
PSID front panel display, 3-8
PSID specifications, 1-2-4

R rate divider, 3-30
readme.txt, 1-5
recall hardware image, 3-55
recall ID settings, 3-59
rename user patterns, 3-62
reset, 3-7, 3-49
return to Microsoft Windows, 3-43
RF output, 3-21
Run, 2-44

S sample and hold, 2-19
save hardware image, 3-55
save ID settings, 3-59
save WGL file, 3-41
screen
 return to normal display, 3-11
screen commands, 3-5
search, 3-45
select all, 3-45
select user pattern
 AM, 2-30
 FM, 2-35
 frequency hop, 2-42
 PM, 2-38
sequence jump source, 3-21
sequence jump type, 3-30
sequence mode, 3-31
sequencer model, 3-23
sequence system clock, 3-22
shutdown, 3-7, 3-49
SID Control Panel, 3-17

- attenuator, 3-19
- coherence, 3-19
- group packet advance, 3-20
- RF output, 3-21
- sequence jump source, 3-21
- sequencer model, 3-23
- sequence system clock, 3-22
- trigger setting, 3-23
- SID Event Markers
 - event marker 1, 3-34
 - event marker 2, 3-34
 - marker address, 3-35
 - marker delay, 3-35
- SID Extended Control Panel
 - active memory, 3-28
 - AM memory mode, 3-28
 - dynamic data mode, 3-28
 - memory address out, 3-29
 - PM data mode, 3-29
 - rate divider, 3-30
 - sequence jump type, 3-30
 - sequence mode, 3-31
 - stretch factor, 3-32
- SID front panel, 3-3
- SID front panel display, 3-8
- signal control, 3-51
 - continue, 3-53
 - pause, 3-53
 - start, 3-53
 - stop, 3-53
 - trigger, 3-53
- special functions, 3-72
- specifications, 1-2-4
- start signal, 3-53
- status bar, 3-5
- stop system, 3-53
- store WGL program, 3-81
- stretch factor, 3-32
- system busy indicators, 3-9
- system reset, 3-49

- T** test signal, 3-65
- tile, 3-83
- title bar, 3-4
- toggle ribbon, 3-5, 3-7, 3-79
 - abort, 3-7
 - reset, 3-7
 - RSID, 3-8
 - shutdown, 3-7
 - SID, 3-8
 - wrkstn, 3-8
- trigger setting, 3-23
- trigger system, 3-53

- U** undo, 3-45
- user patterns, 2-16, 3-61
 - AM, 2-30
 - copy pattern to floppy, 3-62
 - delete, 3-62
 - delete all patterns, 3-62
 - edit, 3-62
 - expansion modes, 2-19
 - FM, 2-35
 - frequency hop, 2-42
 - how to create in WGL, 2-21
 - install pattern from floppy, 3-62
 - patterns on floppy disk, 3-62
 - PM, 2-38
 - rename pattern, 3-62
 - scaling, 2-17
- Utilities Menu
 - CW signal, 3-64
 - diagnostics, 3-63
 - hardware images, 3-54
 - ID settings, 3-58
 - level calibration, 3-65
 - shutdown, 3-49
 - signal control, 3-51
 - system reset, 3-49
 - test signal, 3-65
 - user patterns, 3-61

W

- waveform
 - AM, 2-29
 - FM, 2-34
 - frequency hop, 2-42
 - PM, 2-37
- WGL Menu
 - clear workspace, 3-81
 - load WGL program, 3-81
 - store WGL program, 3-81
 - WGL stack, 3-81
 - WGL status, 3-81
- WGL stack, 3-81
- WGL status, 3-81
- WGL workstation, 3-8
- Window Menu
 - arrange icons, 3-83
 - cascade, 3-83
 - tile, 3-83
- windows tutorial, 3-9
- workstation, WGL, 3-8
- wrkstn, 3-8